

Saab

Fiches techniques du véhicule





Avis juridique :

Ce guide pour services de secours est exclusivement réservé à titre indicatif au personnel de secours dûment formées dans le cadre d'une assistance technique sur les véhicules Saab lors d'accidents de la route. Ce guide pour services de secours se réfère exclusivement à la technologie de véhicules destinés à la vente dans l'Union européenne. La technologie des véhicules des autres marchés et des séries de modèles non énumérées ici peut différer ; pour des raisons de sécurité, ce guide pour services de secours n'est pas applicable pour ces véhicules. Le guide ne contient pas non plus de représentations graphiques de véhicules avec direction à droite.

Sous réserve de modifications concernant la technique, l'équipement et la forme des véhicules par rapport aux données et illustrations du guide pour services de secours ainsi que de modifications du présent guide pour services de secours.

Les utilisateurs trouveront des informations détaillées sur le mode de fonctionnement de leur véhicule dans le manuel d'utilisation de ce véhicule. Les ateliers et concessionnaires obtiendront les informations techniques par leurs fournisseurs habituels.

Copyright 2009 Saab Deutschland GmbH
Rüsselsheim, Germany

L'élaboration du guide pour services de secours et la mise à disposition des fiches techniques de véhicules ont été faites avec le soutien amical de l'entreprise Moditech Rescue Solutions, Pays-Bas.







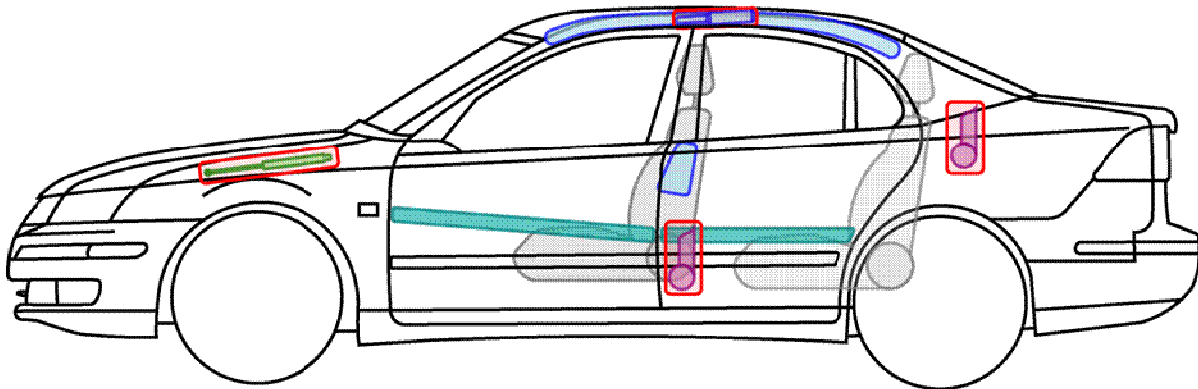
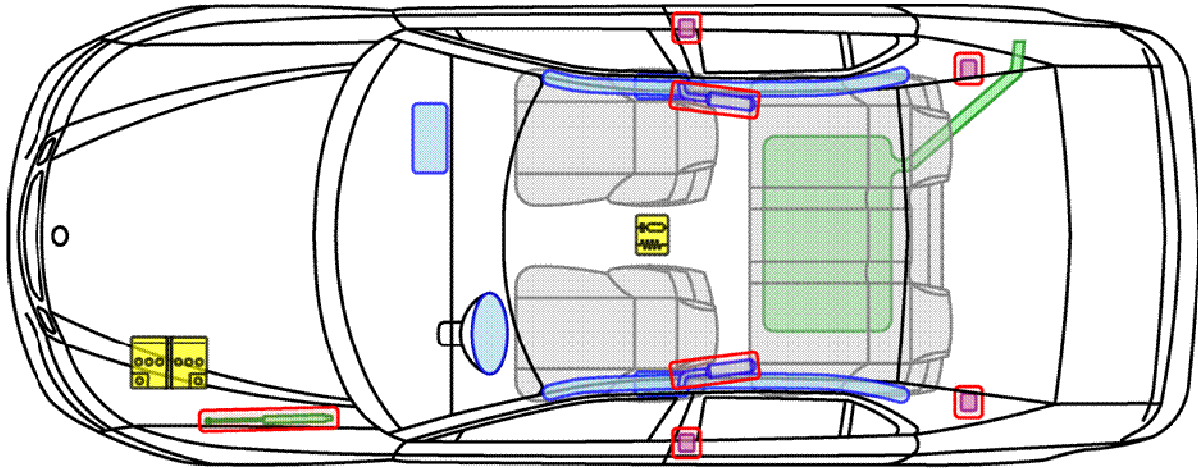

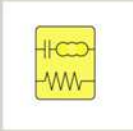
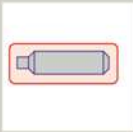

TOUS DROITS RESERVES

La reproduction sous n'importe quelle forme, la traduction ou le prêt, la location ou la vente de ce document, entièrement ou en partie, n'est autorisé qu'avec l'accord préalable d'Saab Deutschland GmbH. Toutes les informations, illustrations et spécifications contenues dans ce documents se basent sur les dernières informations parues et disponibles au moment de la publication de ce document. Saab Deutschland GmbH se réserve le droit d'effectuer des changements à tout moment et sans annonce préalable.

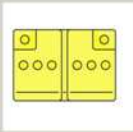

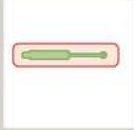



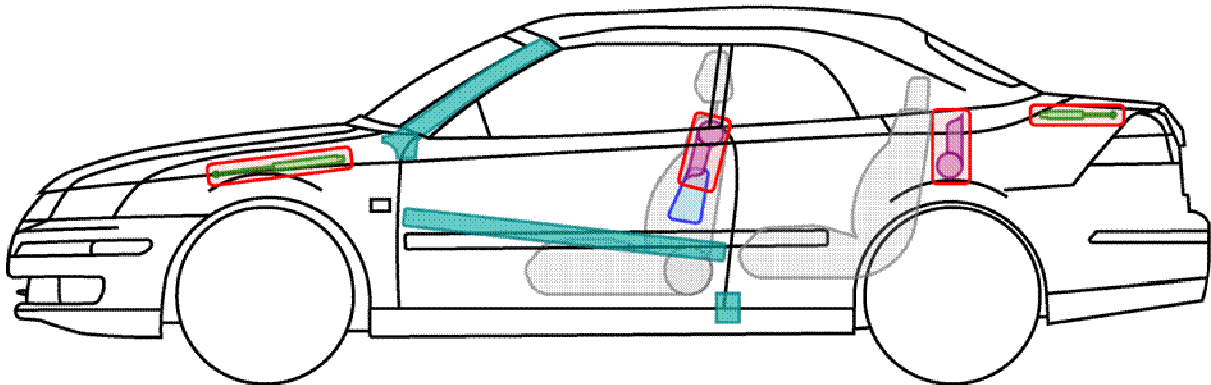
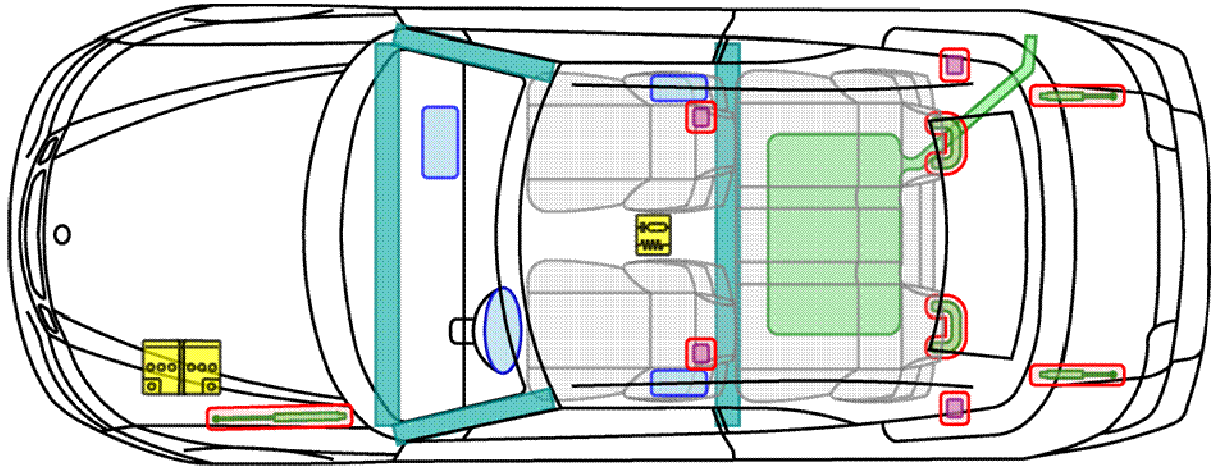

Légende

	Airbag		Renfort de carrosserie		Module de commande
	Générateur de gaz		Protection anti-écrasement		Batterie
	Tendeur de ceinture		Amortisseur pneumatique		Réservoir à carburant

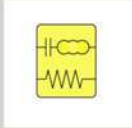
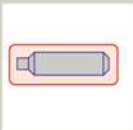

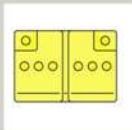
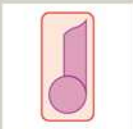
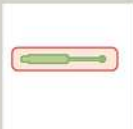



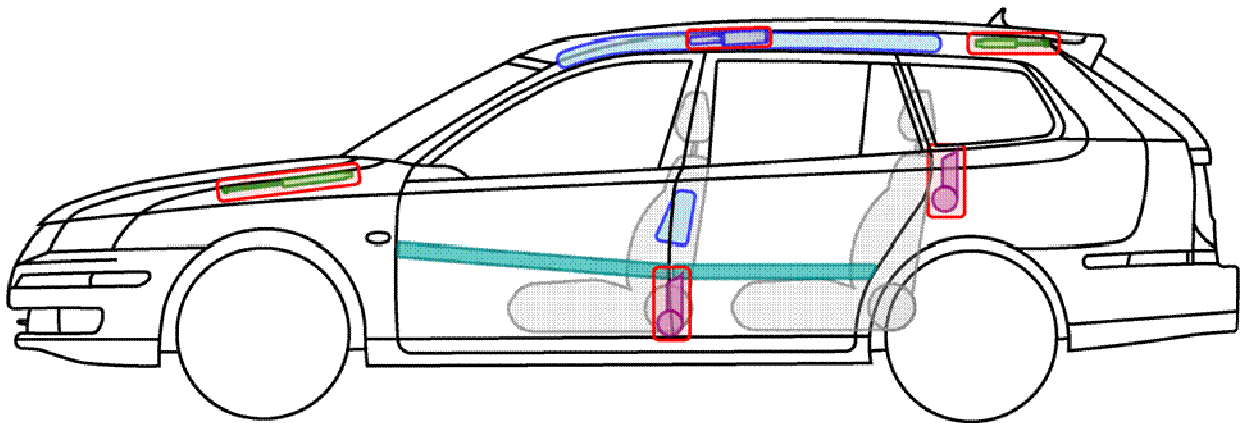
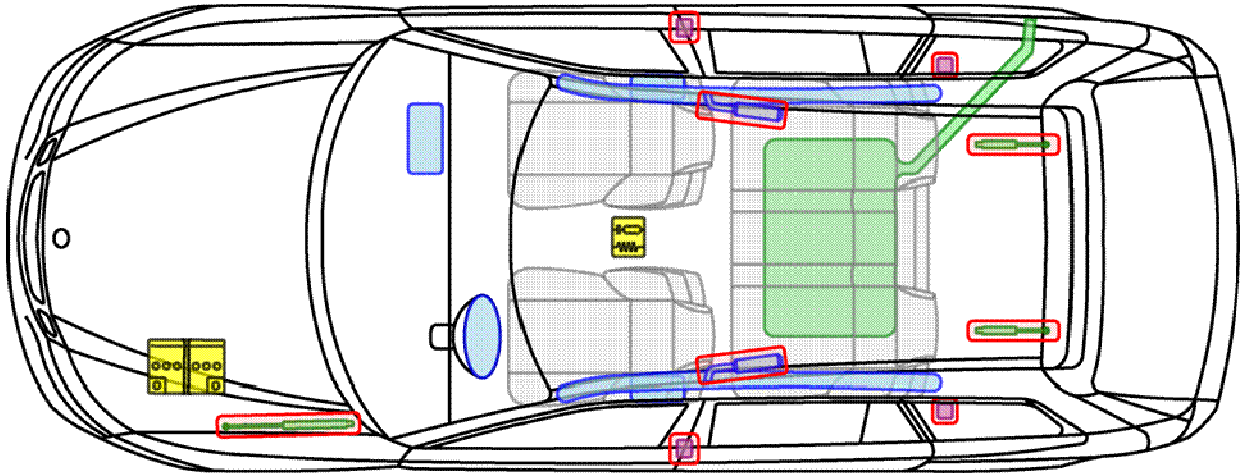

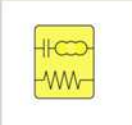
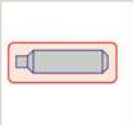

Légende

	Airbag		Renfort de carrosserie		Module de commande
	Générateur de gaz		Protection anti-écrasement		Batterie
	Tendeur de ceinture		Amortisseur pneumatique		Réservoir à carburant

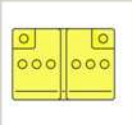

Légende

	Airbag		Renfort de carrosserie		Module de commande
	Générateur de gaz		Protection anti-écrasement		Batterie
	Tendeur de ceinture		Amortisseur pneumatique		Réservoir à carburant

9-5

4-portes

Année de construction 1997 →

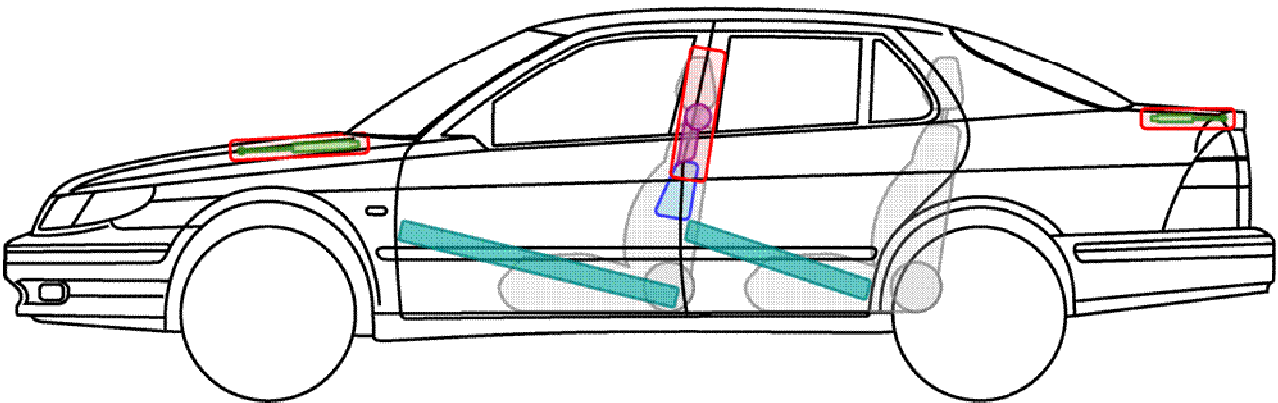
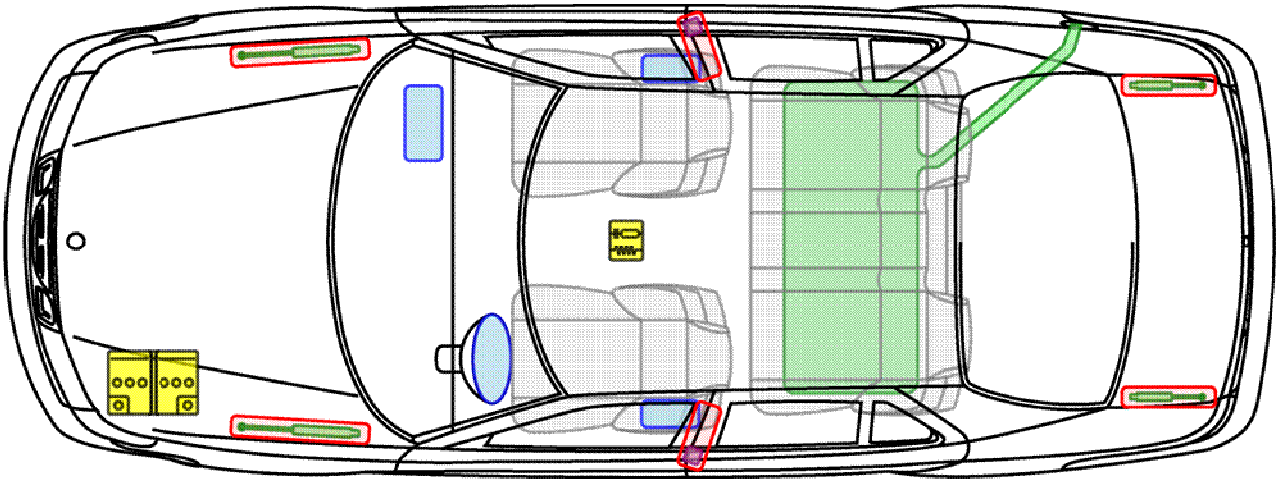

Légende

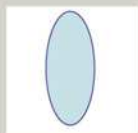

Airbag



Renfort de carrosserie



Module de commande

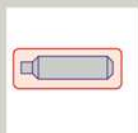

Générateur de gaz



Protection anti-écrasement

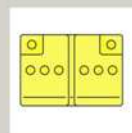

Batterie

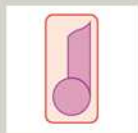

Tendeur de ceinture

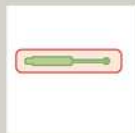

Amortisseur pneumatique







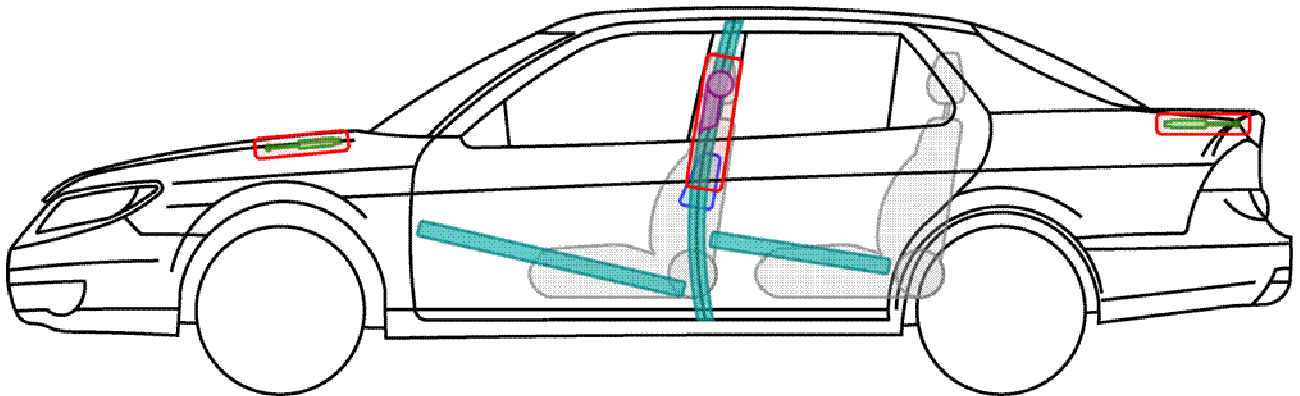
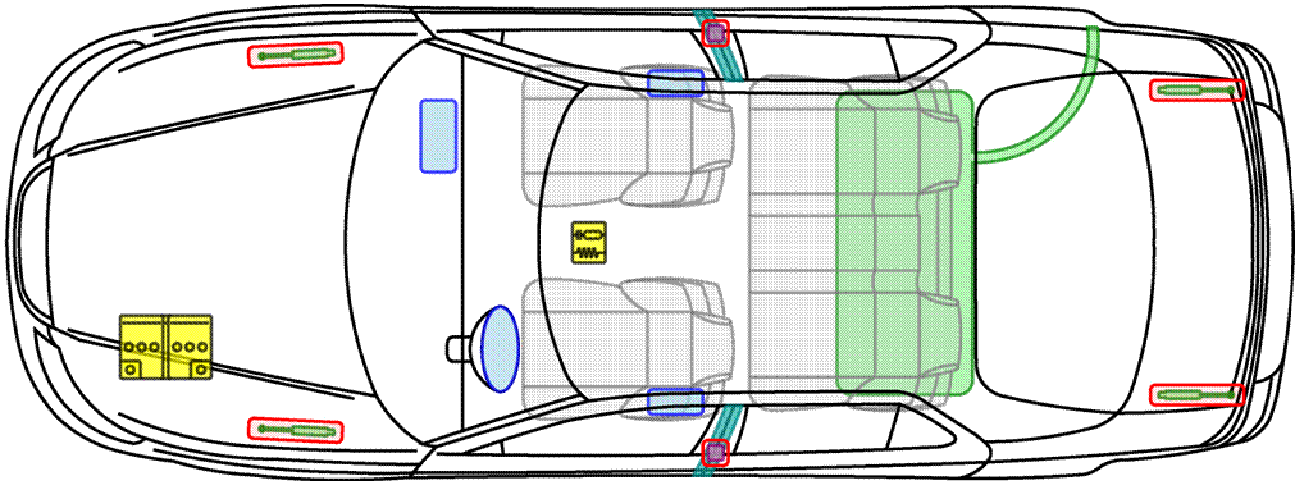

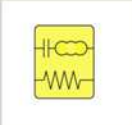
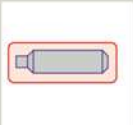

Réservoir à carburant

9-5

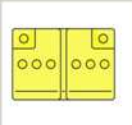

Légende

	Airbag		Renfort de carrosserie		Module de commande
	Générateur de gaz		Protection anti-écrasement		Batterie
	Tendeur de ceinture		Amortisseur pneumatique		Réservoir à carburant





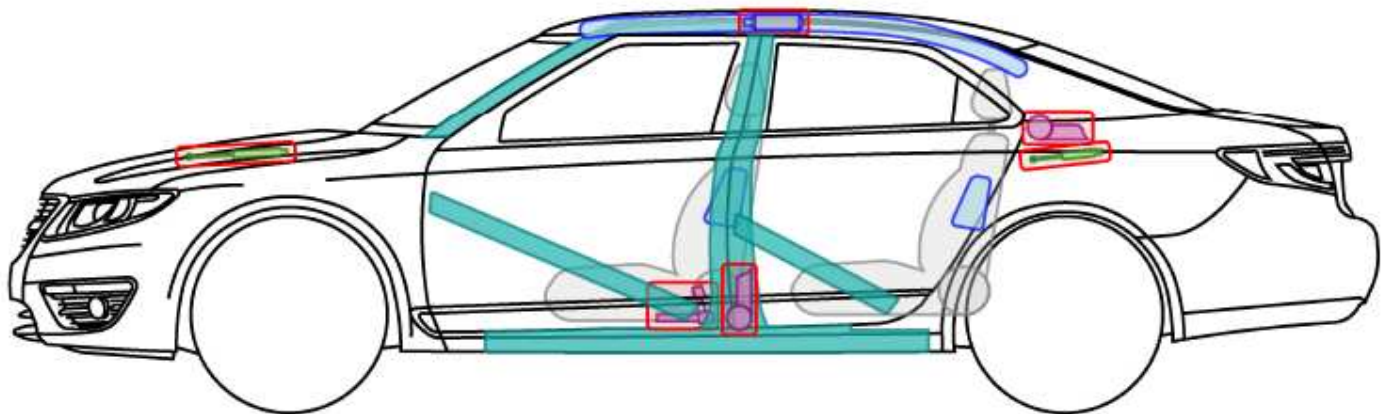
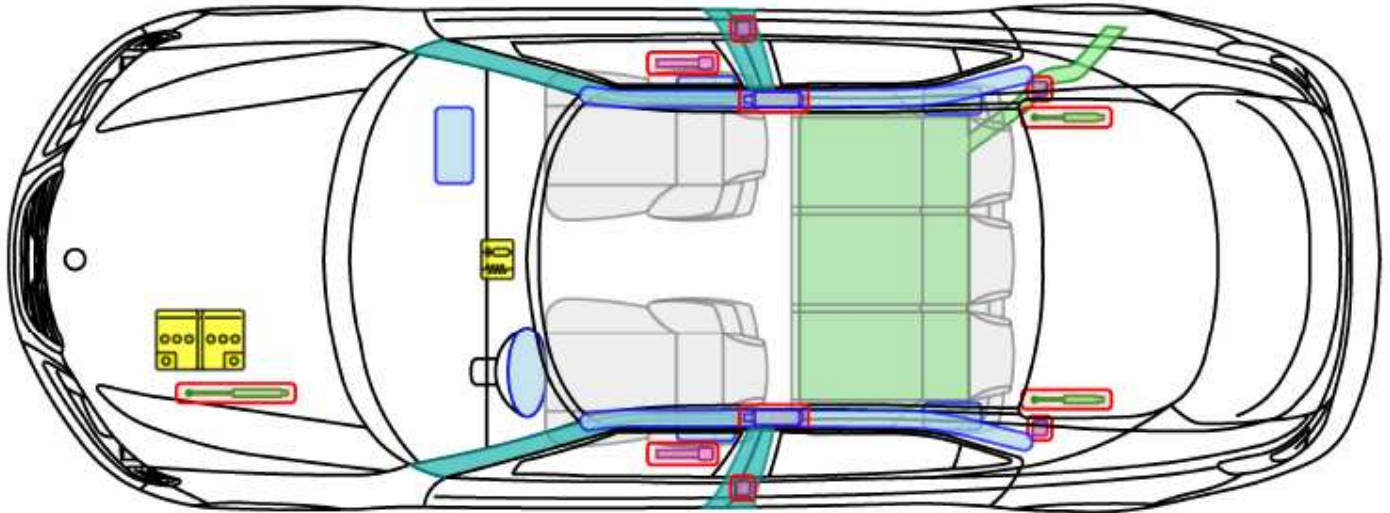

9-5

4-portes

Année de construction 2010 →

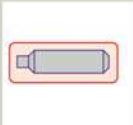

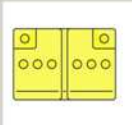
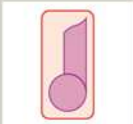
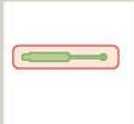





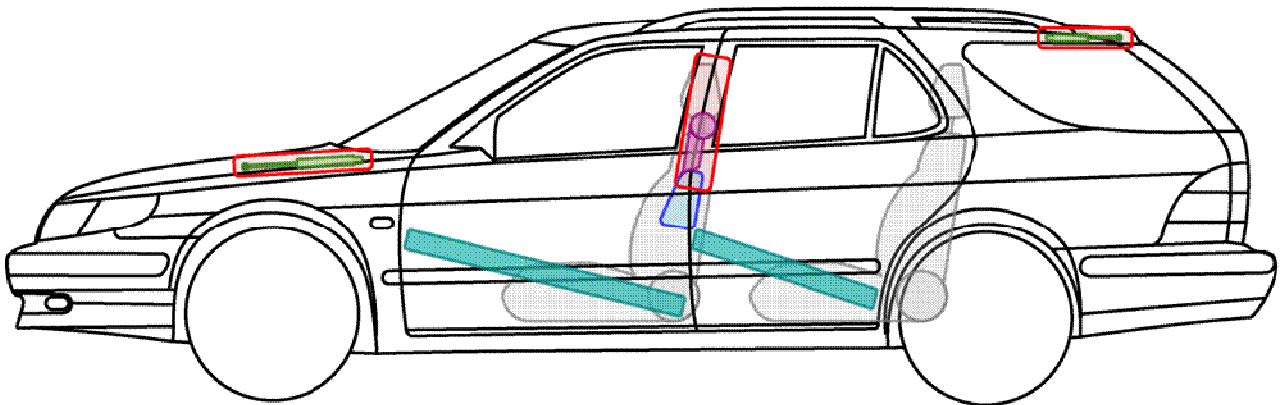
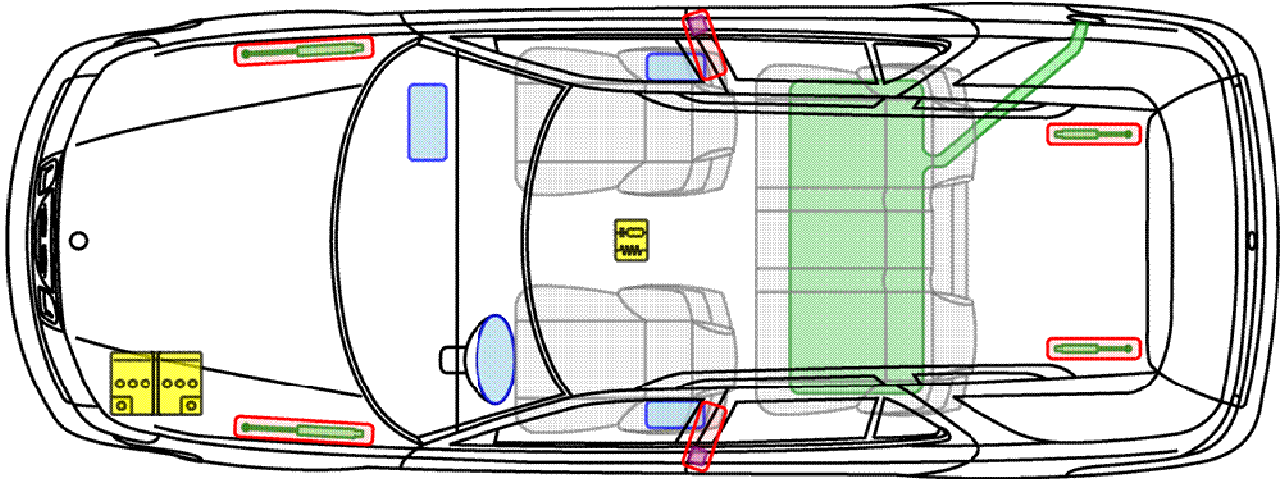

Légende

	Airbag		Renfort de carrosserie		Module de commande
	Générateur de gaz		Protection anti-écrasement		Batterie
	Tendeur de ceinture		Amortisseur pneumatique		Réservoir à carburant

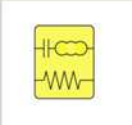
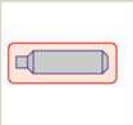
9-5

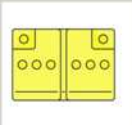

Légende

	Airbag		Renfort de carrosserie		Module de commande
	Générateur de gaz		Protection anti-écrasement		Batterie
	Tendeur de ceinture		Amortisseur pneumatique		Réservoir à carburant







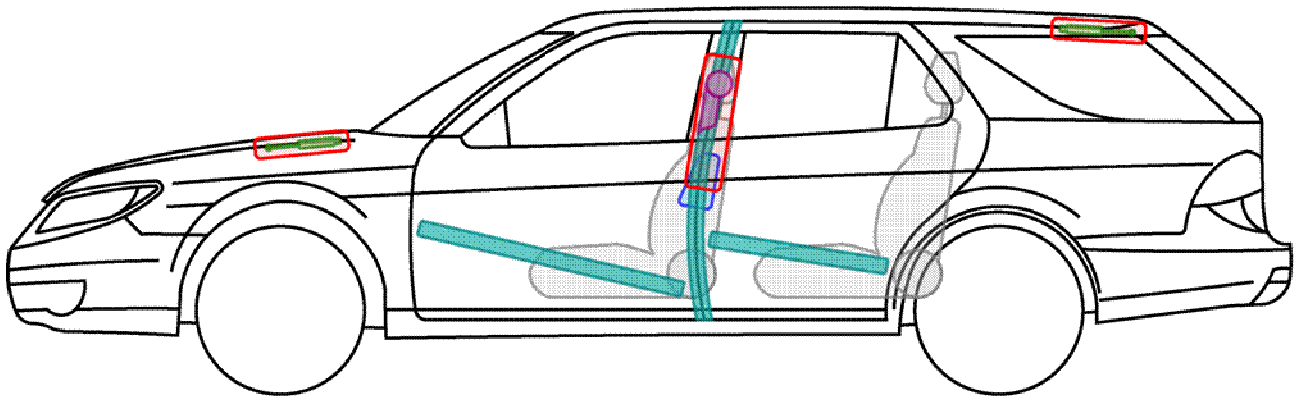
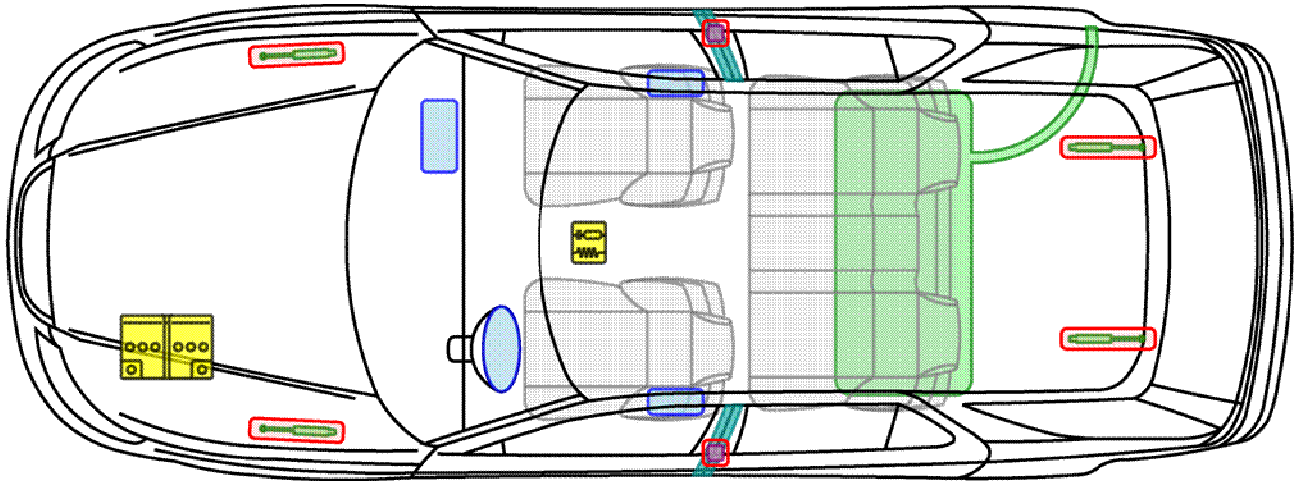

9-5

Break (SportCombi)

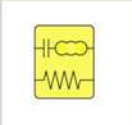
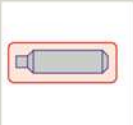
Année de construction 2005 →

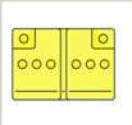

Légende

	Airbag		Renfort de carrosserie		Module de commande
	Générateur de gaz		Protection anti-écrasement		Batterie
	Tendeur de ceinture		Amortisseur pneumatique		Réservoir à carburant

9-5