



Fiches de désincarcération Voitures particulières

Mercedes-Benz • AMG • McLaren • Maybach • smart



Mercedes-Benz



Mercedes-Benz

Avant-propos

Chères lectrices, chers lecteurs,

Comme la tradition le veut, l'un des objectifs essentiels de Mercedes-Benz est d'assurer le maximum de sécurité possible.

Parallèlement à un concept global de sécurité, il convenait aussi de mettre à la disposition des équipes de secours des informations détaillées sur nos véhicules et leurs systèmes de sécurité.

L'objectif premier des équipes de secours est de sauver des vies. A cet effet, celles-ci doivent accéder le plus rapidement possible aux personnes blessées, sans les mettre en danger ni s'exposer elles-mêmes à des risques supplémentaires.

À ce titre, une formation approfondie du personnel de secours est fondamentale. Il est par ailleurs indispensable de connaître les possibilités d'accès spécifiques au type du véhicule ainsi que le fonctionnement et la réaction des systèmes de sécurité se trouvant à bord.

Outre le **"Guide à l'usage des services de secours"**, les **"fiches de désincarcération"** diffusées par Mercedes-Benz fournissent dès à présent, sous forme comprimée, les informations utiles concernant de nombreux modèles et séries, **depuis le début de production 1979** (camping-car à partir de 1995).

Les propriétaires de véhicule et les secouristes peuvent télécharger les fiches de désincarcération gratuitement sur internet.

Les fiches de désincarcération sont réalisées en couleur. Ceci permet une présentation claire et une lecture rapide du contenu. De ce fait, nous conseillons vivement d'effectuer une **impression en couleur**.

Daimler AG



Remarque

Sur les fiches de désincarcération, les renforts de carrosserie correspondent généralement à des zones qui ne peuvent être découpées par les secouristes, à l'aide d'outils standard, que moyennant des efforts nettement plus importants qu'à l'ordinaire. Les indications relatives aux renforts de carrosserie se limitent par conséquent aux zones dont la découpe peut s'avérer nécessaire pour le sauvetage des occupants et que le chef d'intervention devrait connaître.

© 2010 by Daimler AG

Cet ouvrage ainsi que tous ses éléments est protégé par des droits d'auteur.

Toute exploitation ou utilisation commerciale requiert l'autorisation écrite préalable de Daimler AG, département GSP/OIS, HPC R822, W002, D-70546 Stuttgart.







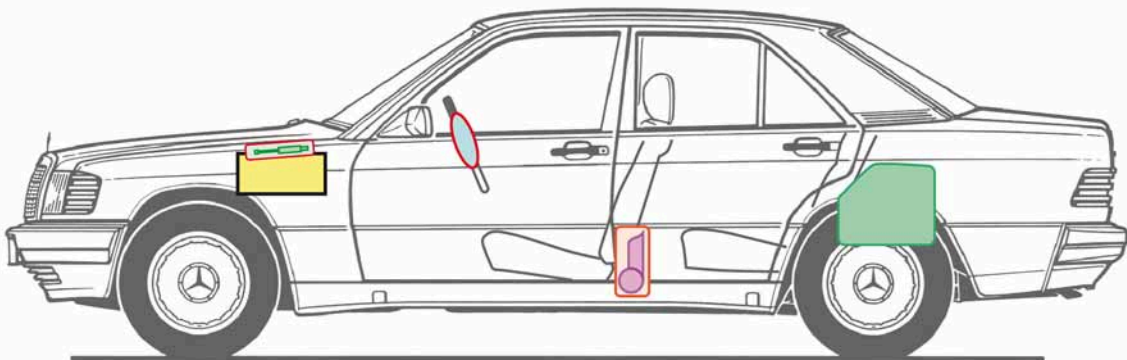
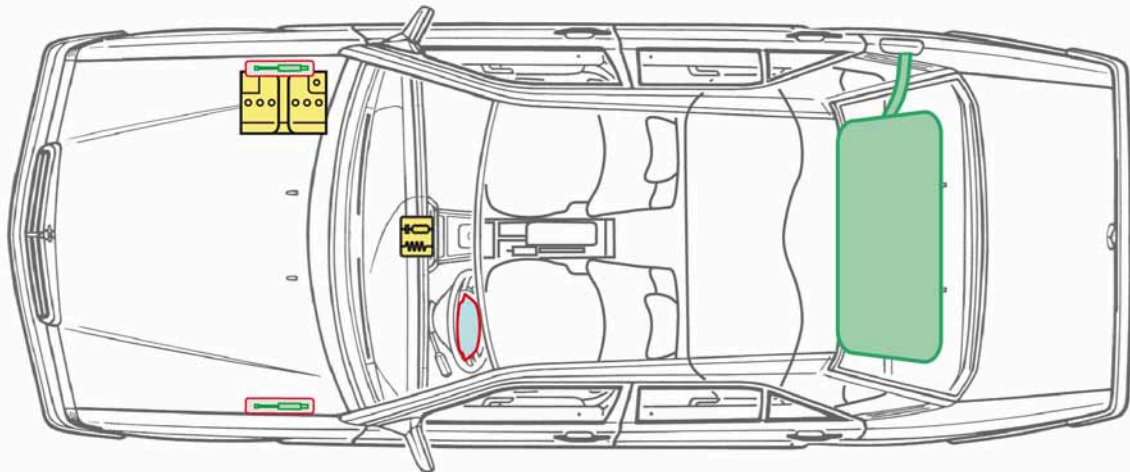

Cette règle s'applique notamment à la reproduction, à la diffusion, au traitement, à la traduction, au microfilmage ainsi qu'à l'enregistrement et/ou au traitement par des systèmes électroniques, y compris les bases de données et services en ligne.

**190
Berline
Type 201**

1982-1993



Légende

	Airbag		Renfort de carrosserie		Calculateur
	Générateur de gaz		Arceau de sécurité		Batterie
	Rétracteur de ceinture		Amortisseur à gaz		Réservoir de carburant





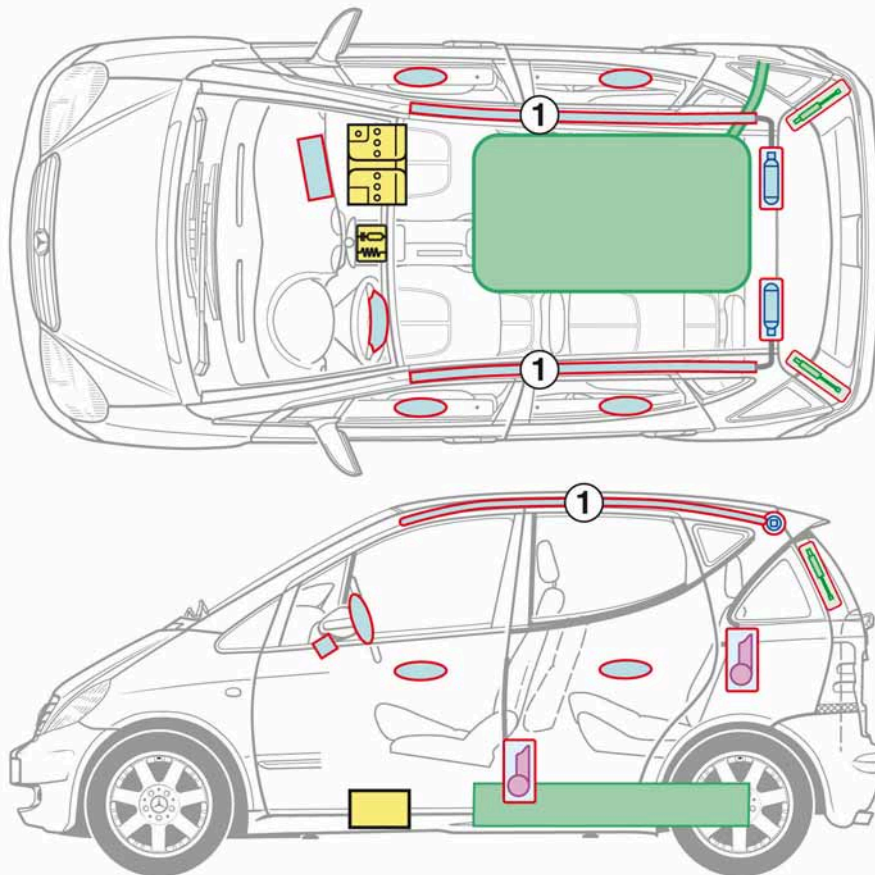

**Classe A
Berline
Type 168**

1997-2004

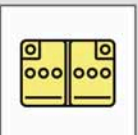
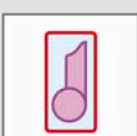
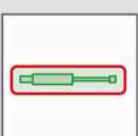

1 à partir de 2001

Légende

	Airbag		Renfort de carrosserie		Calculateur
	Générateur de gaz		Arceau de sécurité		Batterie
	Rétracteur de ceinture		Amortisseur à gaz		Réservoir de carburant





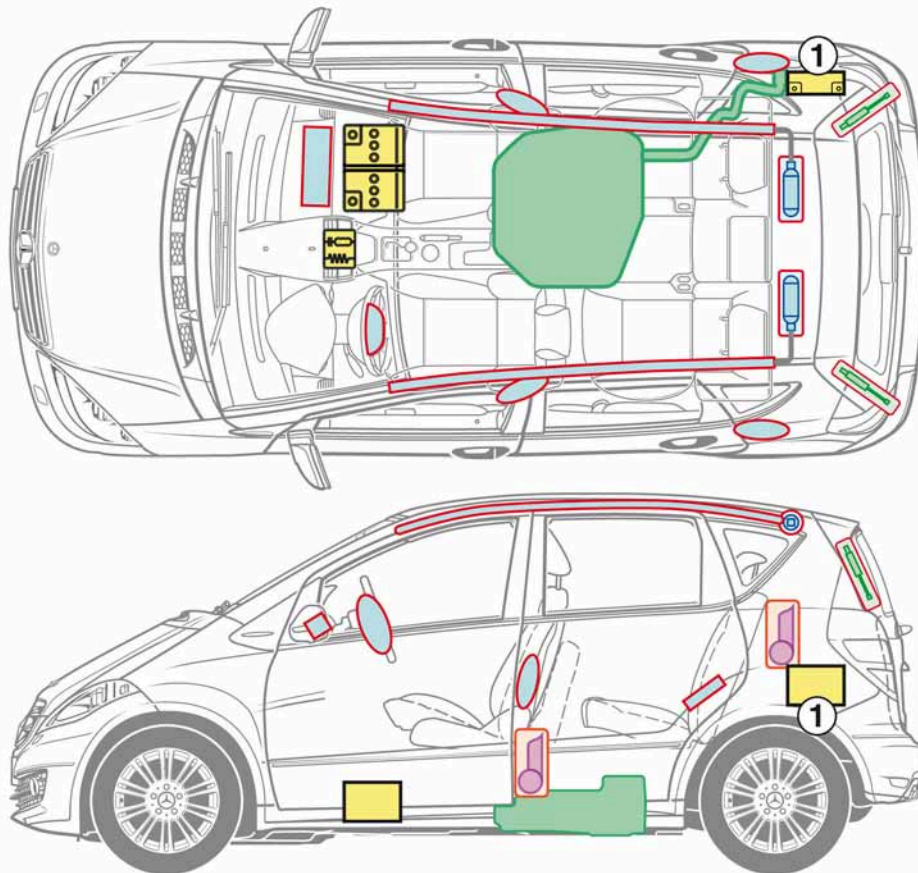



**Classe A
Berline
Type 169**

à partir de 2004

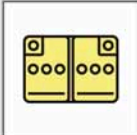

1 batterie additionnelle sur les modèles BlueEFFICIENCY

Légende

	Airbag		Renfort de carrosserie		Calculateur
	Générateur de gaz		Arceau de sécurité		Batterie
	Rétracteur de ceinture		Amortisseur à gaz		Réservoir de carburant





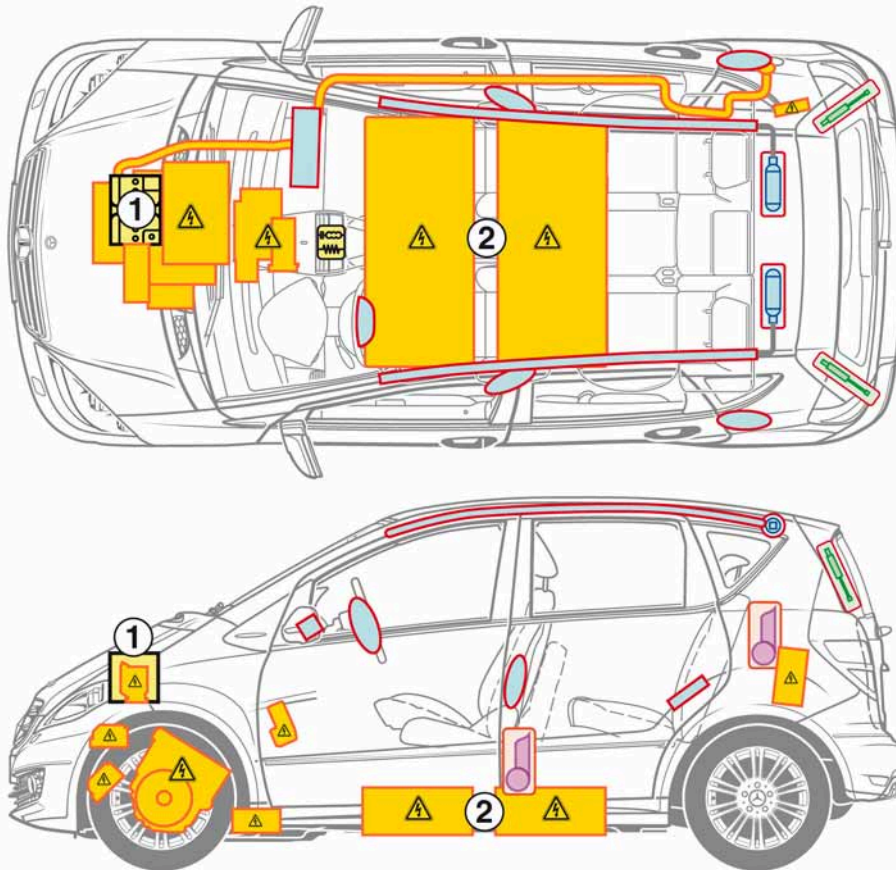



Classe A
E-Cell
Berline
Type 169

à partir de 2010

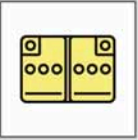

- 1 batterie 12 V
2 batterie haute tension

Légende

	Airbag		Renfort de carrosserie		Calculateur
	Générateur de gaz		Arceau de sécurité		Batterie
	Rétracteur de ceinture		Amortisseur à gaz		Composants haute tension





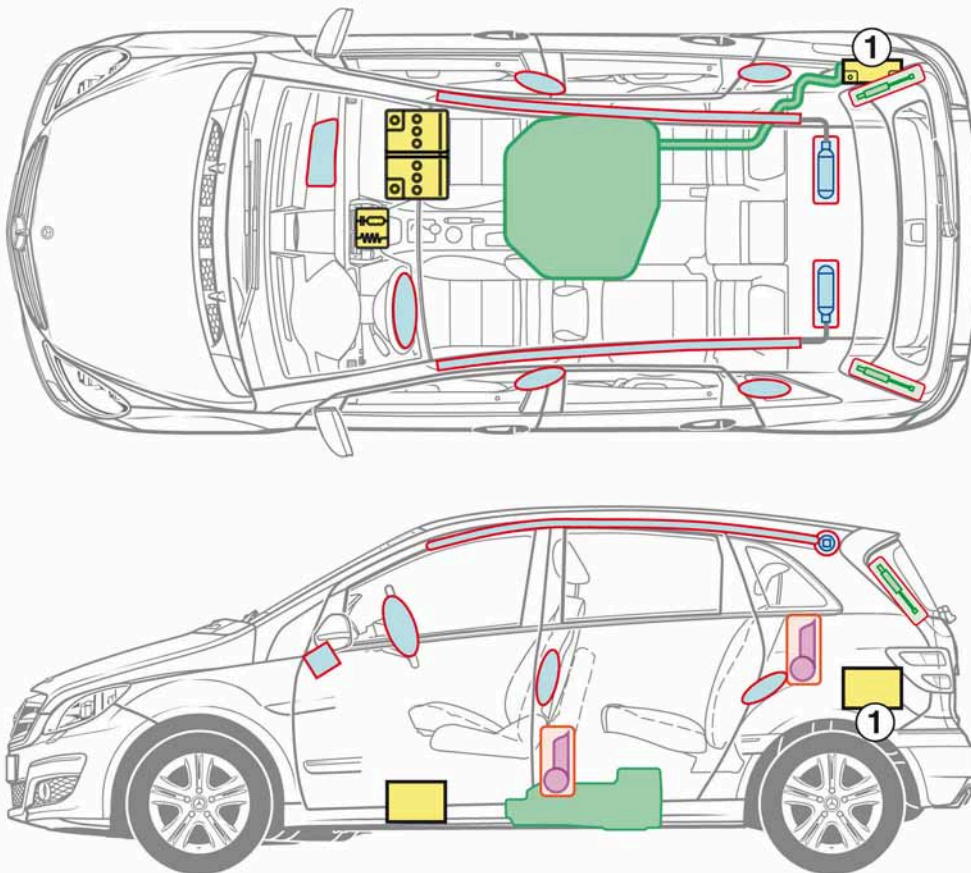



**Classe B
Berline
Type 245**

à partir de 2005

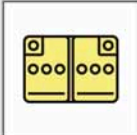

1 batterie additionnelle sur les modèles BlueEFFICIENCY

Légende

	Airbag		Renfort de carrosserie		Calculateur
	Générateur de gaz		Arceau de sécurité		Batterie
	Rétracteur de ceinture		Amortisseur à gaz		Réservoir de carburant





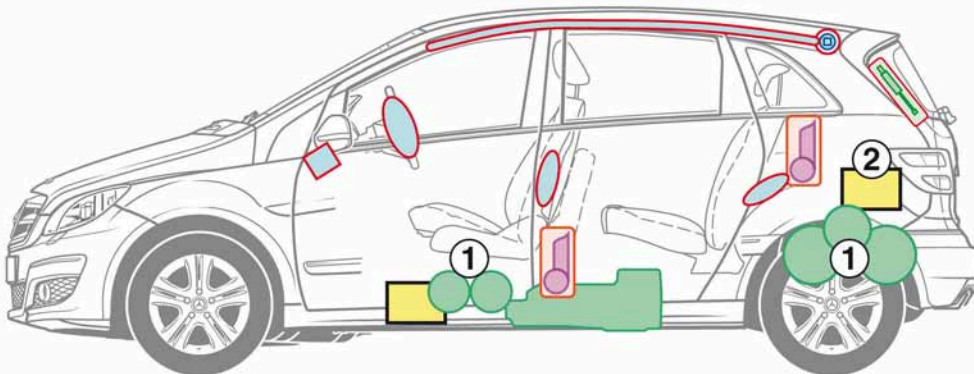
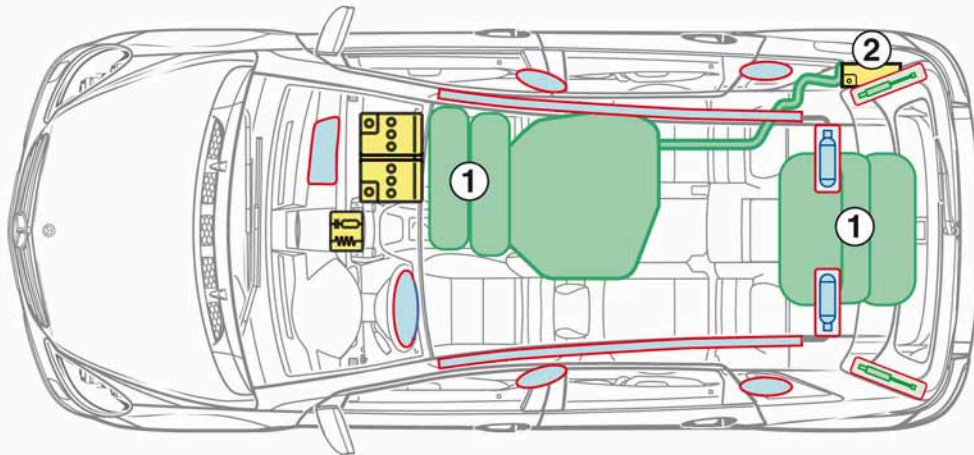



Classe B
NGT
Berline
Type 245

à partir de 2005

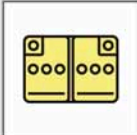

1 réservoir à gaz
2 batterie additionnelle sur les modèles BlueEFFICIENCY

Légende

	Airbag		Renfort de carrosserie		Calculateur
	Générateur de gaz		Arceau de sécurité		Batterie
	Rétracteur de ceinture		Amortisseur à gaz		Réservoir de carburant



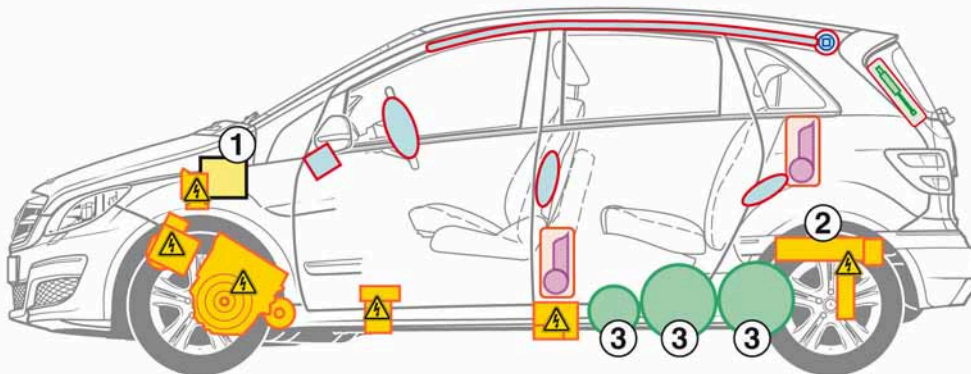
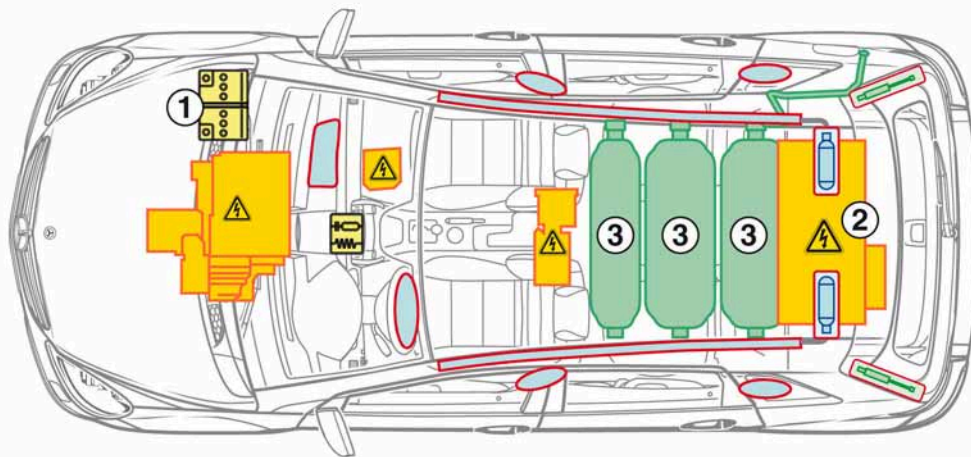





Classe B
F-Cell
Moteur à pile à combustible
Type 245
à partir de 2010

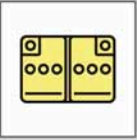

1 batterie 12 V
2 batterie haute tension

3 réservoir d'hydrogène

Légende







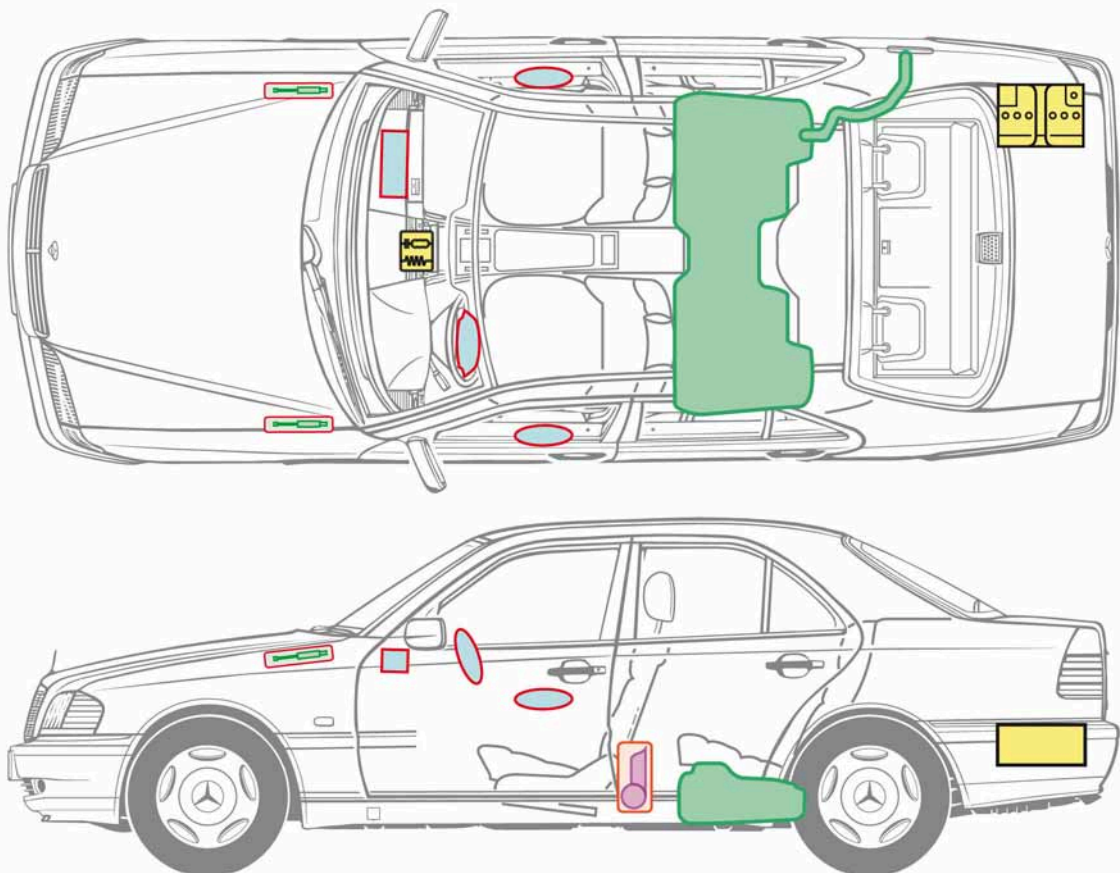

	Airbag		Renfort de carrosserie		Calculateur
	Générateur de gaz		Composants haute tension		Batterie
	Rétracteur de ceinture		Amortisseur à gaz		Réservoir de carburant

**Classe C
Berline
Type 202**

1993-2001

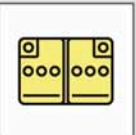

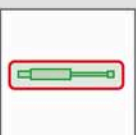
Légende

	Airbag		Renfort de carrosserie		Calculateur
	Générateur de gaz		Arceau de sécurité		Batterie
	Rétracteur de ceinture		Amortisseur à gaz		Réservoir de carburant





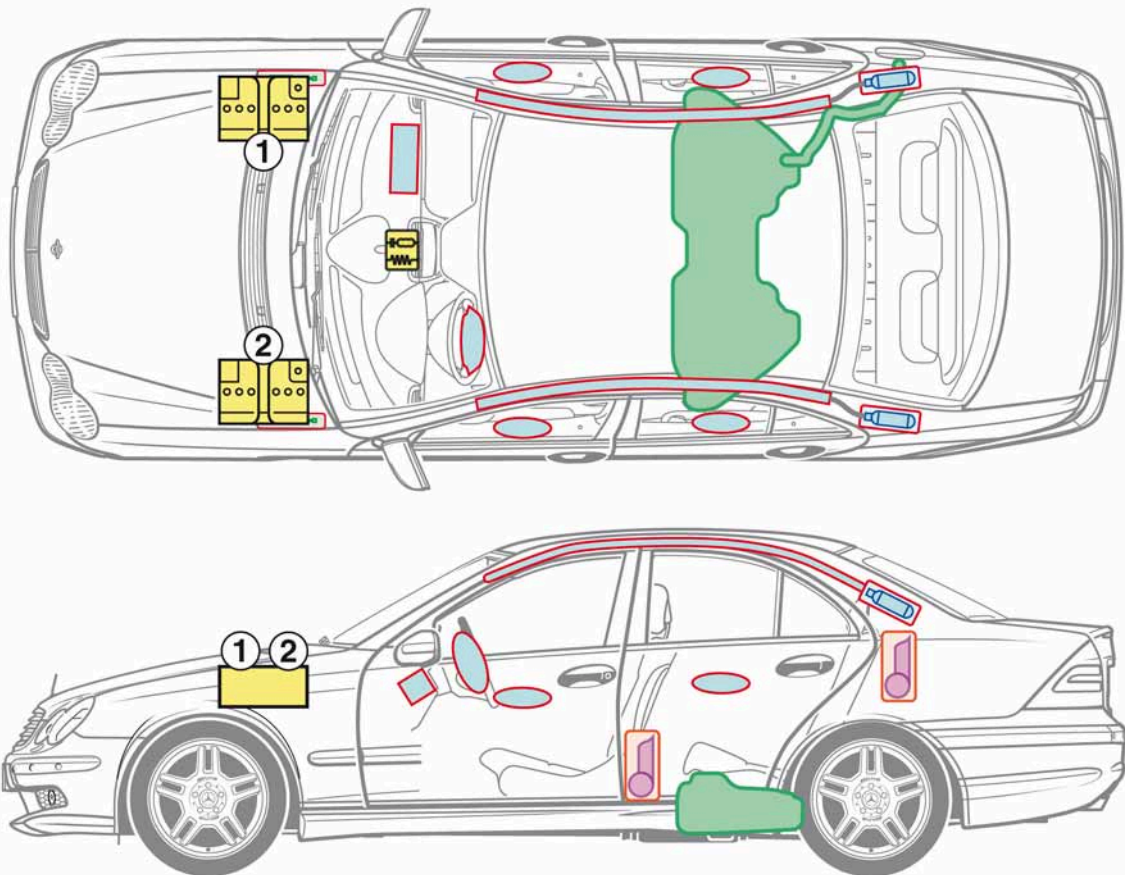



**Classe C
Berline
Type 203**

2000-2007

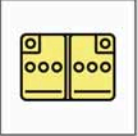

1 direction à gauche
2 direction à droite

Légende

	Airbag		Renfort de carrosserie		Calculateur
	Générateur de gaz		Arceau de sécurité		Batterie
	Rétracteur de ceinture		Amortisseur à gaz		Réservoir de carburant





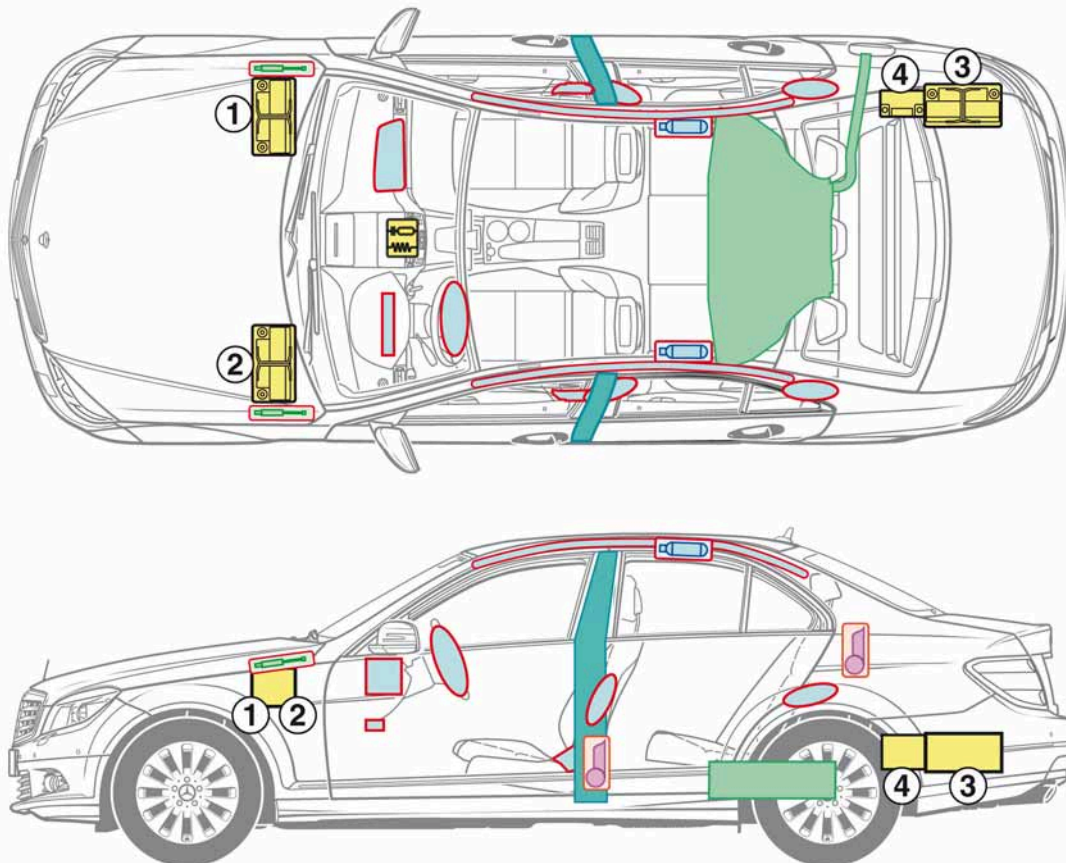

**Classe C
Berline
Type 204**

à partir de 2007

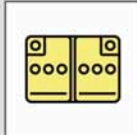
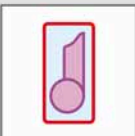
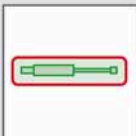

- 1 batterie en véhicules à moteur essence, à partir de 1.12.09 en véhicules à moteur diesel (4- et 8-cyl.) et AMG, dir. à gauche
 2 batterie en véhicules à moteur essence, à partir de 1.12.09 en véhicules à moteur diesel (4- et 8-cyl.) et AMG, dir. à droite
 3 batterie en véhicules à moteur diesel, jusqu'à 30.11.09 en véhicules à moteur diesel (4- et 8-cyl.) et AMG
 4 batterie additionnelle ECO Start-Stop

Légende

	Airbag		Renfort de carrosserie		Calculateur
	Générateur de gaz		Arceau de sécurité		Batterie
	Rétracteur de ceinture		Amortisseur à gaz		Réservoir de carburant





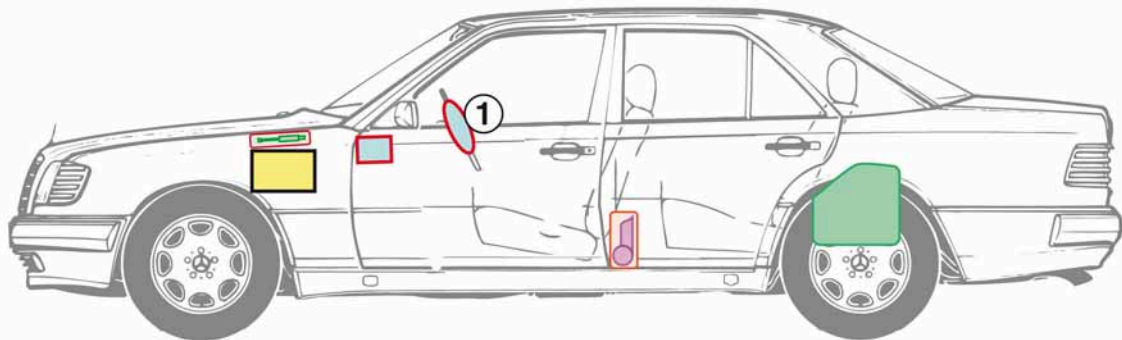
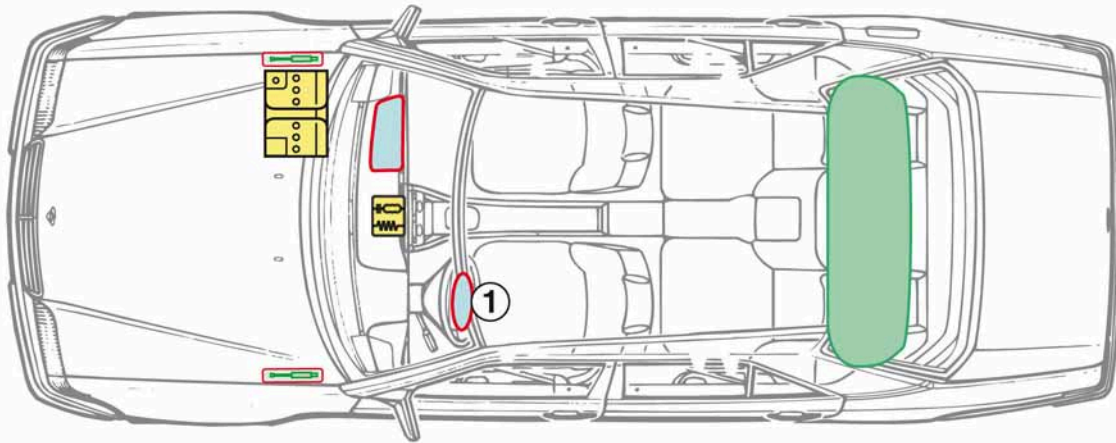

**Classe E
Berline
Type 124**

1984-1995

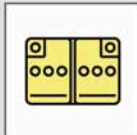
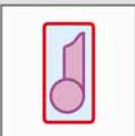
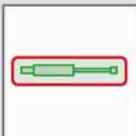

1 Série à partir de 1992

Légende





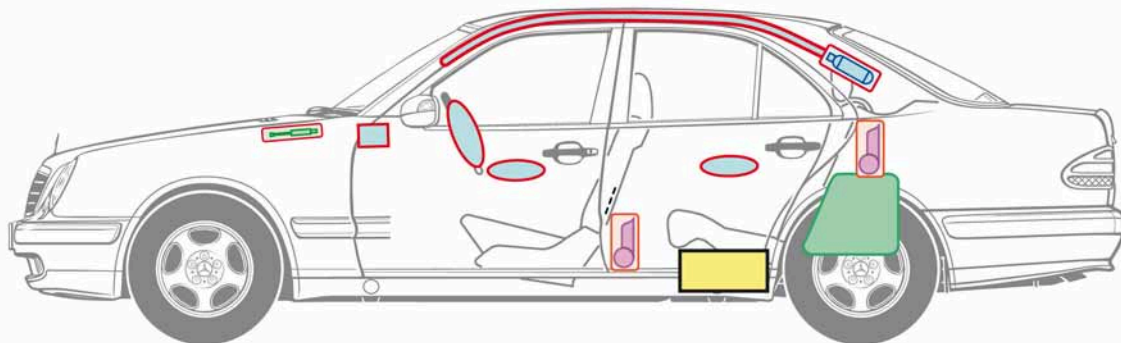
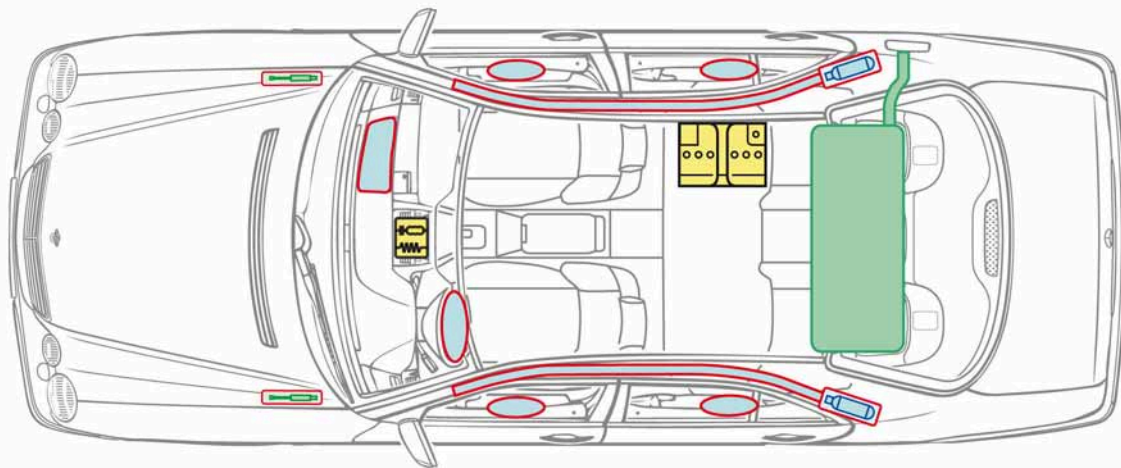

	Airbag		Renfort de carrosserie		Calculateur
	Générateur de gaz		Arceau de sécurité		Batterie
	Rétracteur de ceinture		Amortisseur à gaz		Réservoir de carburant

**Classe E
Berline
Type 210**

1995-2002

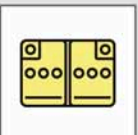
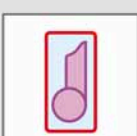
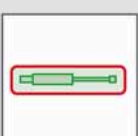

Légende

	Airbag		Renfort de carrosserie		Calculateur
	Générateur de gaz		Arceau de sécurité		Batterie
	Rétracteur de ceinture		Amortisseur à gaz		Réservoir de carburant

**Classe E
Berline
Type 211**



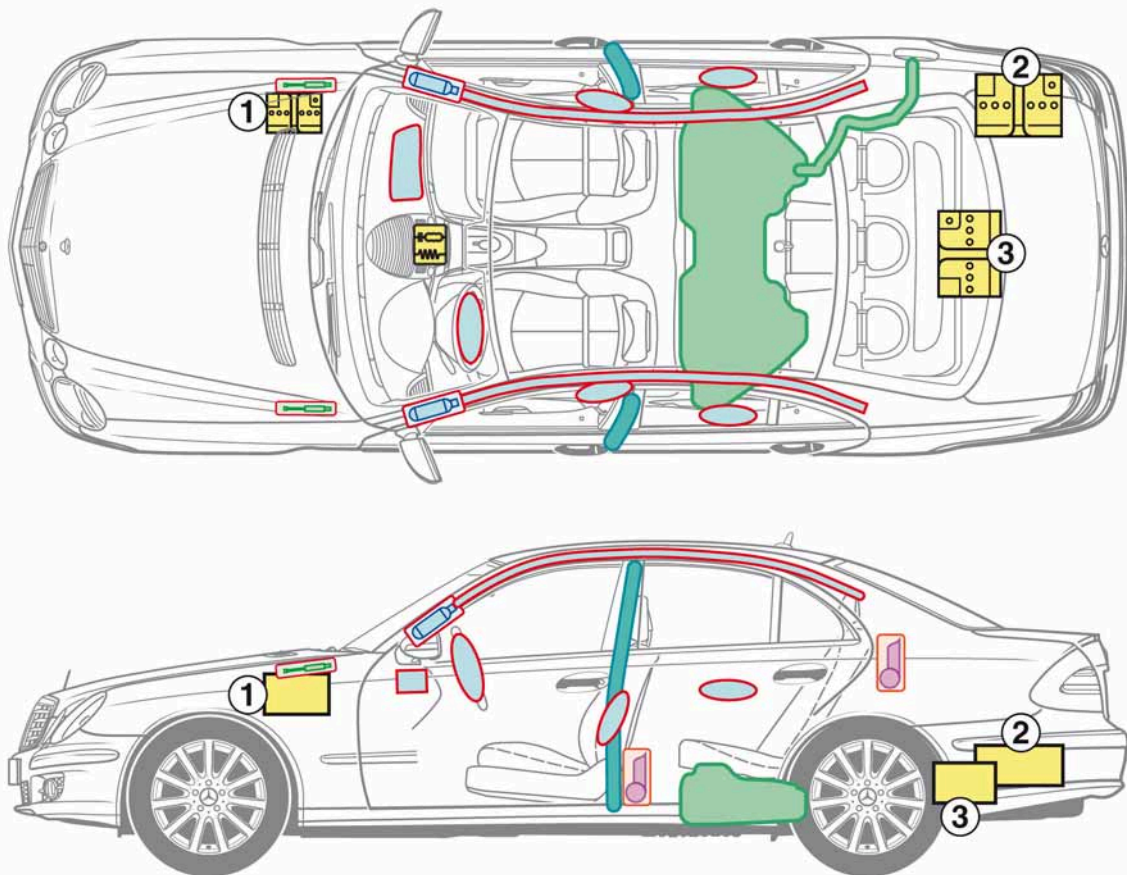





2002-2009



1 batterie additionnelle compartiment moteur
2 batterie principale coffre à bagages
(équipement avec roue de secours)

3 batterie principale coffre à bagages
(équipement sans roue de secours)

Légende

	Airbag		Renfort de carrosserie		Calculateur
	Générateur de gaz		Arceau de sécurité		Batterie
	Rétracteur de ceinture		Amortisseur à gaz		Réservoir de carburant

Classe E
NGT
Berline
Type 211



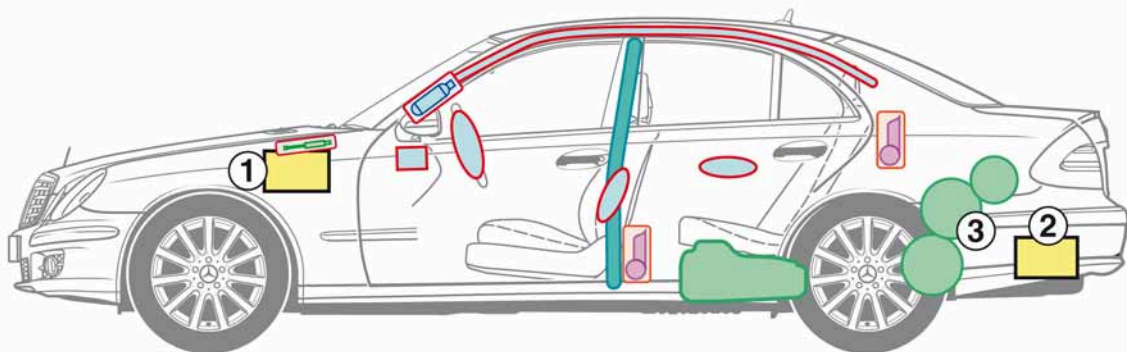
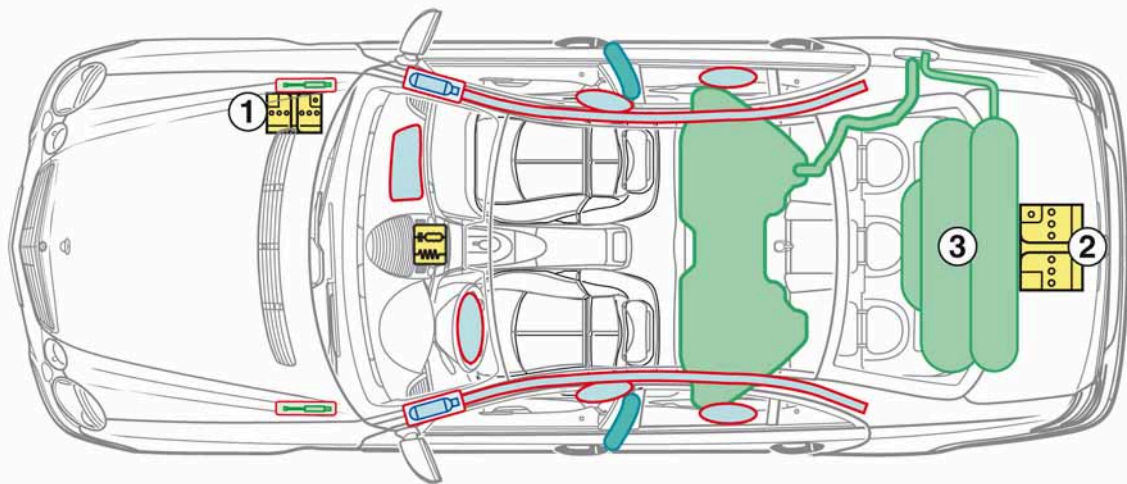





2004-2009

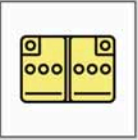

1 batterie additionnelle compartiment moteur
2 batterie principale coffre à bagages

3 réservoir à gaz

Légende

	Airbag		Renfort de carrosserie		Calculateur
	Générateur de gaz		Arceau de sécurité		Batterie
	Rétracteur de ceinture		Amortisseur à gaz		Réservoir de carburant

**Classe E
Berline
Type 212**



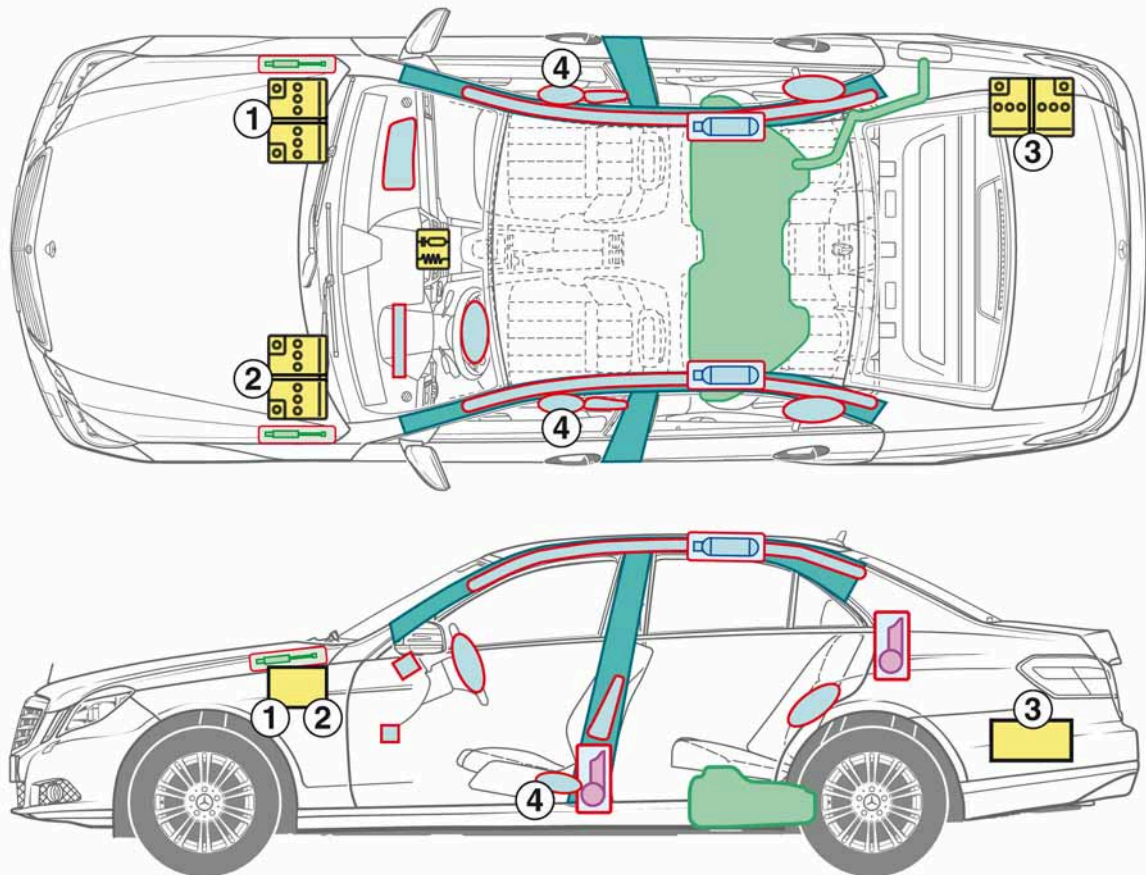



à partir de 2009



1 avec moteur 4 et 6 cylindres, direction à gauche
2 avec moteur 4 et 6 cylindres, direction à droite

3 avec moteur 8 cylindres
4 airbag pelvien (à partir de 06.2009)

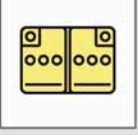
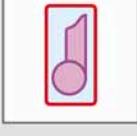
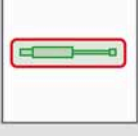
Légende

	Airbag		Renfort de carrosserie		Calculateur
	Générateur de gaz		Arceau de sécurité		Batterie
	Rétracteur de ceinture		Amortisseur à gaz		Réservoir de carburant

**Classe E
NGT
Berline
Type 212**



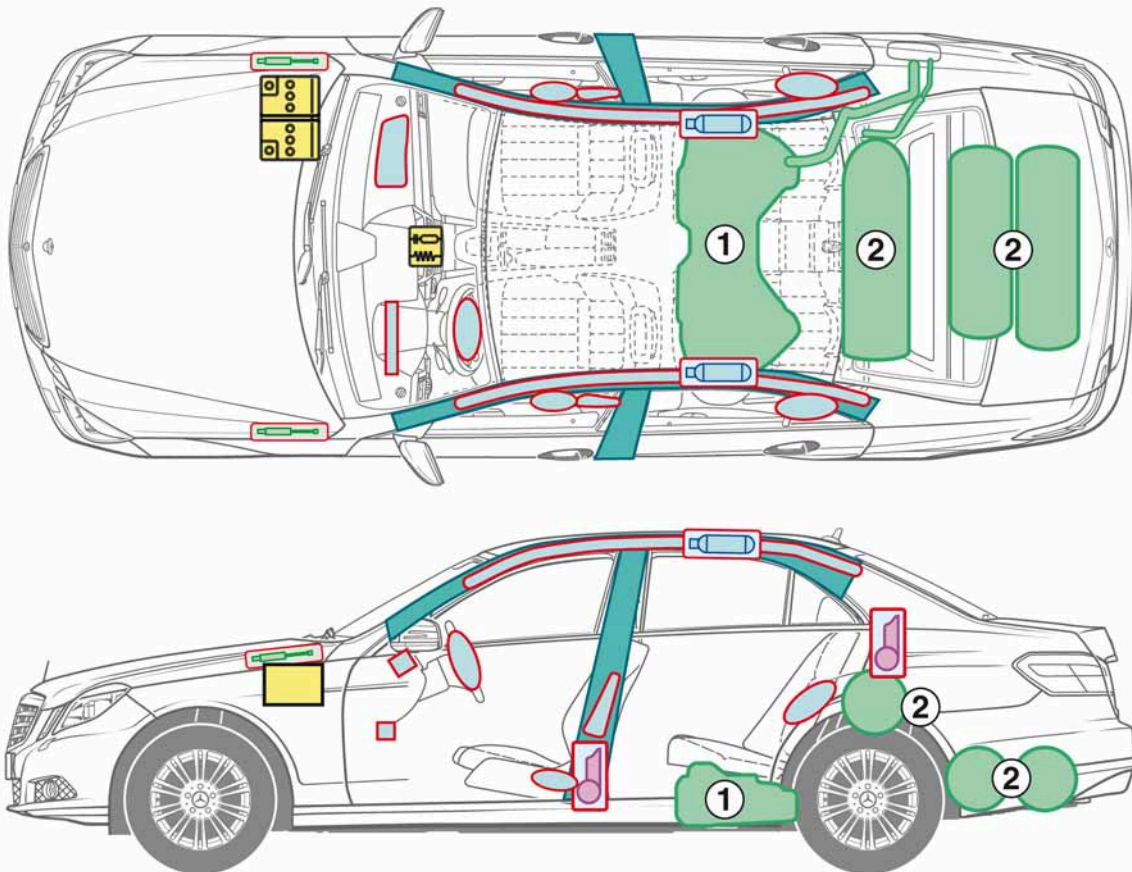



à partir de 2010



1 direction à gauche
2 direction à droite

3 réservoir à gaz

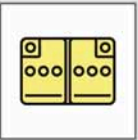
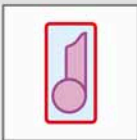
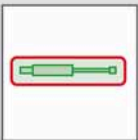
Légende







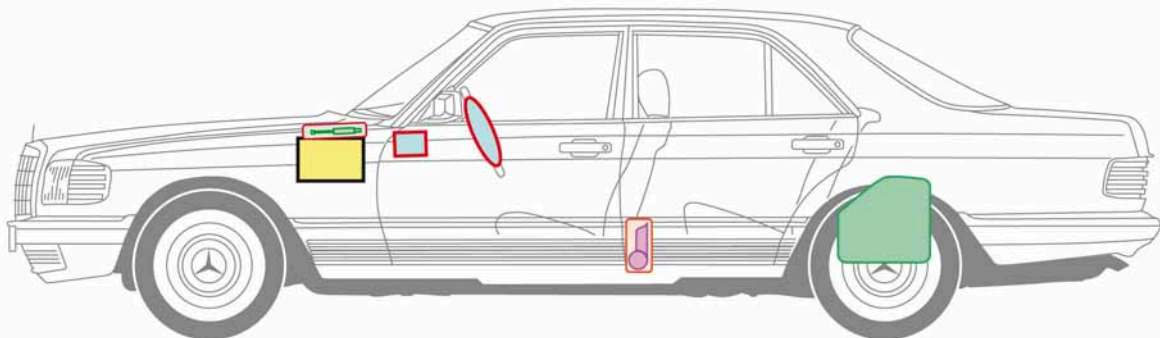
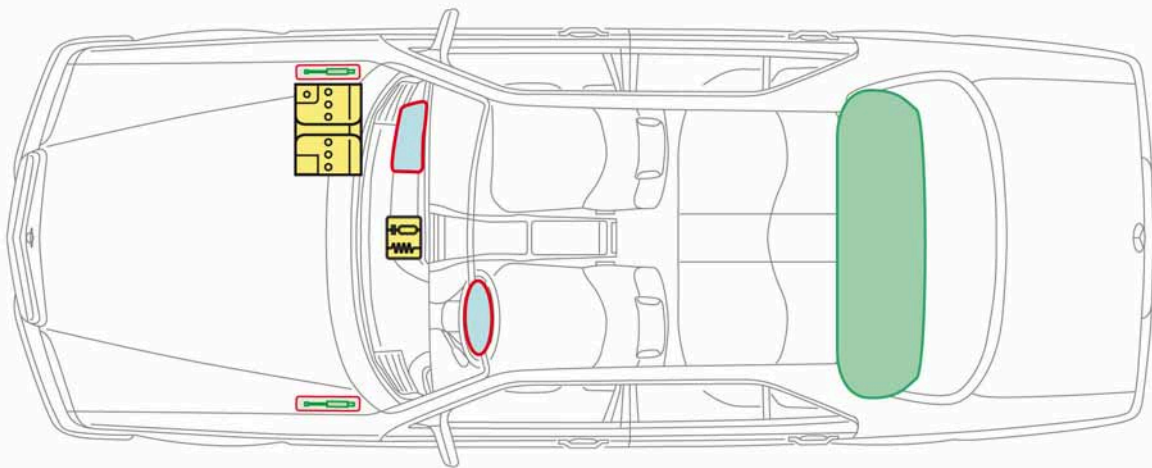

	Airbag		Renfort de carrosserie		Calculateur
	Générateur de gaz		Arceau de sécurité		Batterie
	Rétracteur de ceinture		Amortisseur à gaz		Réservoir de carburant

**Classe S
Berline
Type 126**

1979-1991

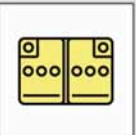

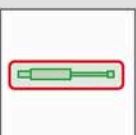
Légende

	Airbag		Renfort de carrosserie		Calculateur
	Générateur de gaz		Arceau de sécurité		Batterie
	Rétracteur de ceinture		Amortisseur à gaz		Réservoir de carburant





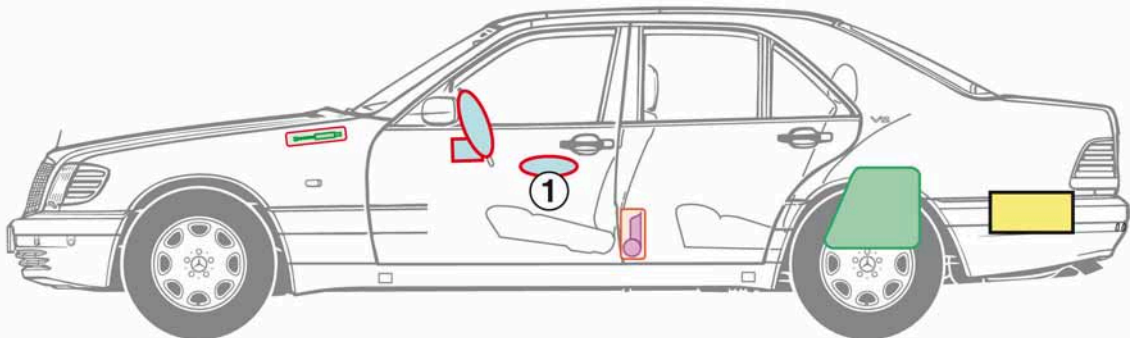
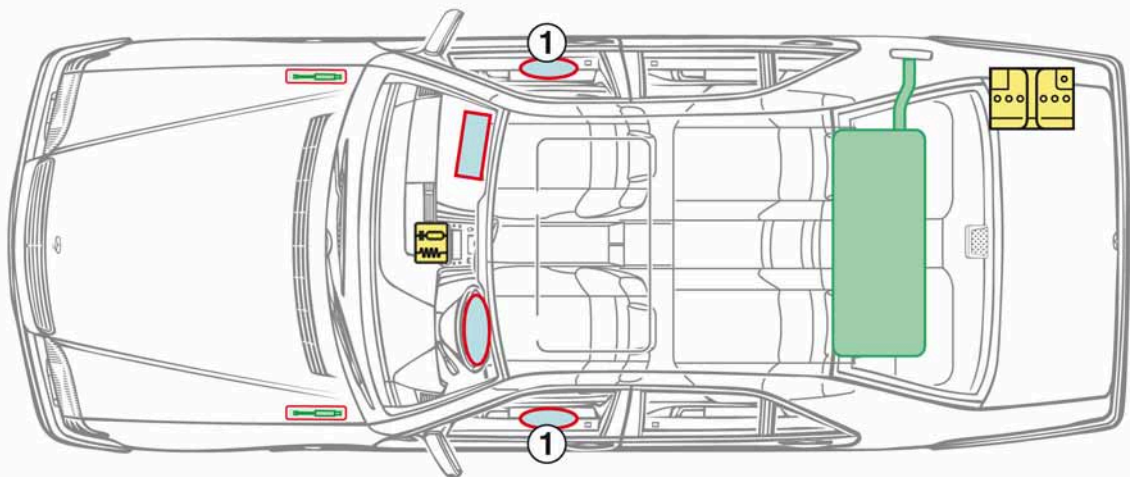



**Classe S
Berline
Type 140**

1991-1998

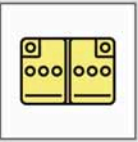

1 option

Légende







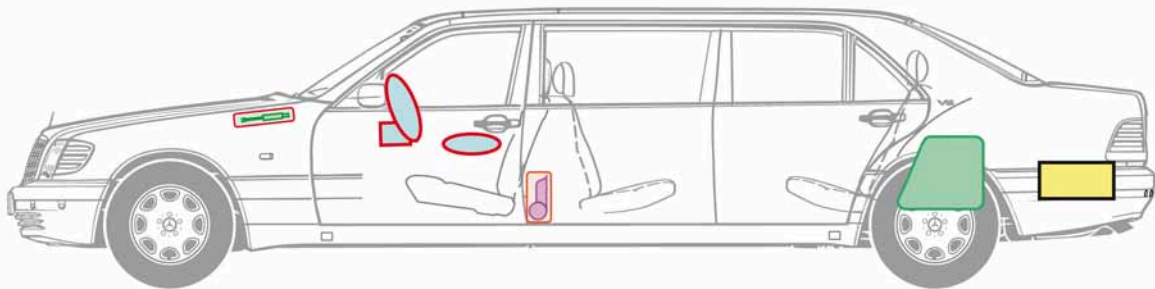
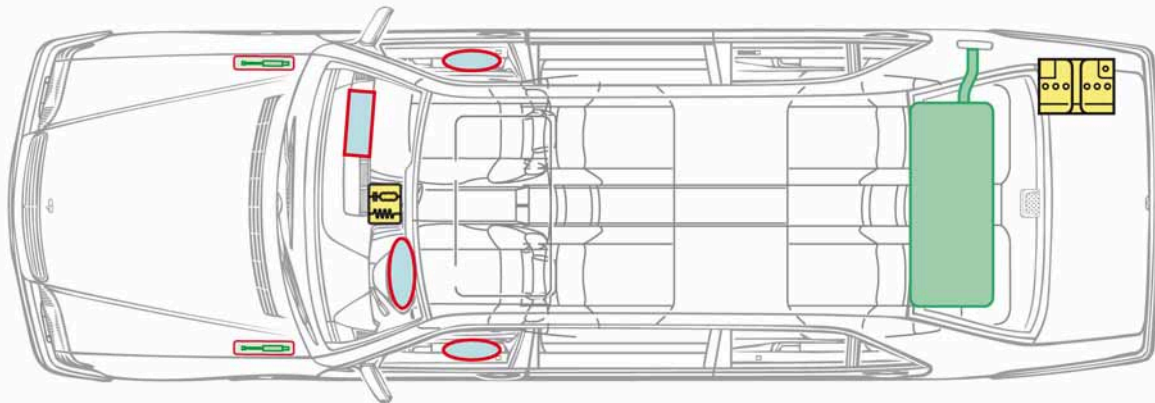

	Airbag		Renfort de carrosserie		Calculateur
	Générateur de gaz		Arceau de sécurité		Batterie
	Rétracteur de ceinture		Amortisseur à gaz		Réservoir de carburant

**Classe S
Pullman
Berline
Type 140**

1996-2000

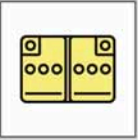

Légende





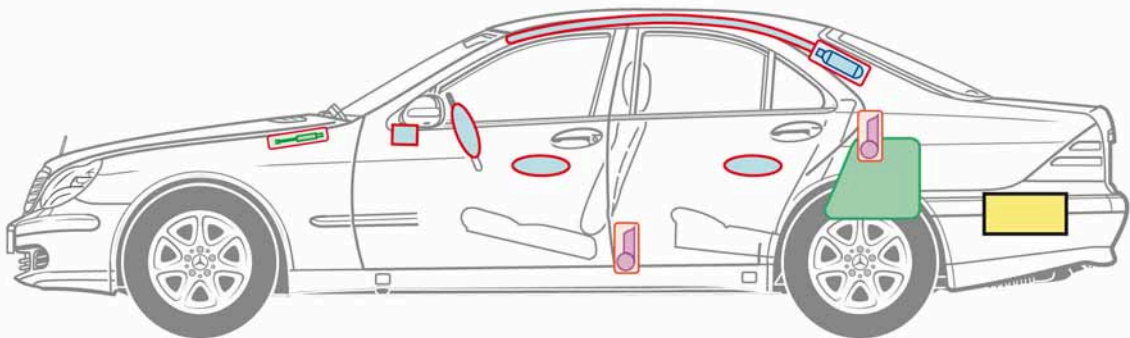
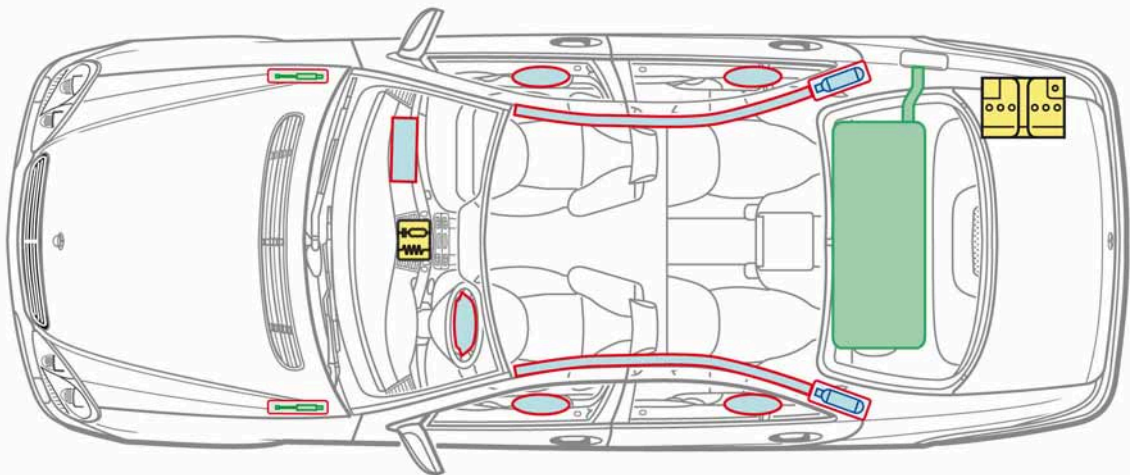

	Airbag		Renfort de carrosserie		Calculateur
	Générateur de gaz		Arceau de sécurité		Batterie
	Rétracteur de ceinture		Amortisseur à gaz		Réservoir de carburant

**Classe S
Berline
Type 220**

1998-2005

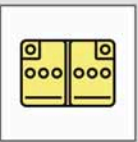
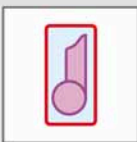
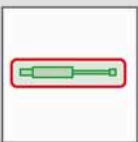

Légende







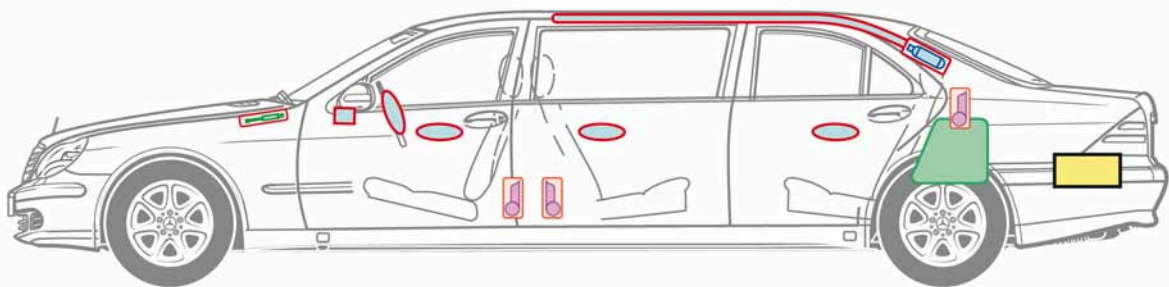
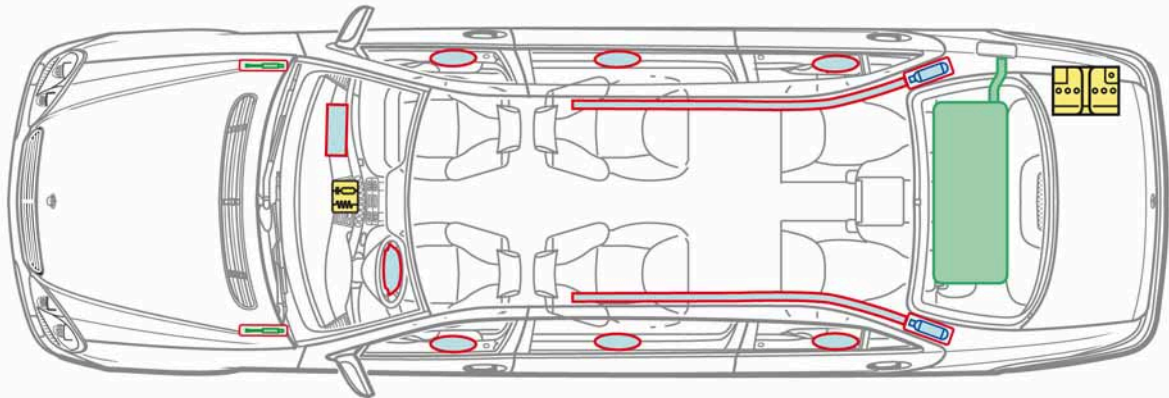

	Airbag		Renfort de carrosserie		Calculateur
	Générateur de gaz		Arceau de sécurité		Batterie
	Rétracteur de ceinture		Amortisseur à gaz		Réservoir de carburant

**Classe S
Pullman
Berline
Type 220**

2000-2005

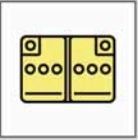

Légende

	Airbag		Renfort de carrosserie		Calculateur
	Générateur de gaz		Arceau de sécurité		Batterie
	Rétracteur de ceinture		Amortisseur à gaz		Réservoir de carburant

**Classe S
Berline
Type 221**



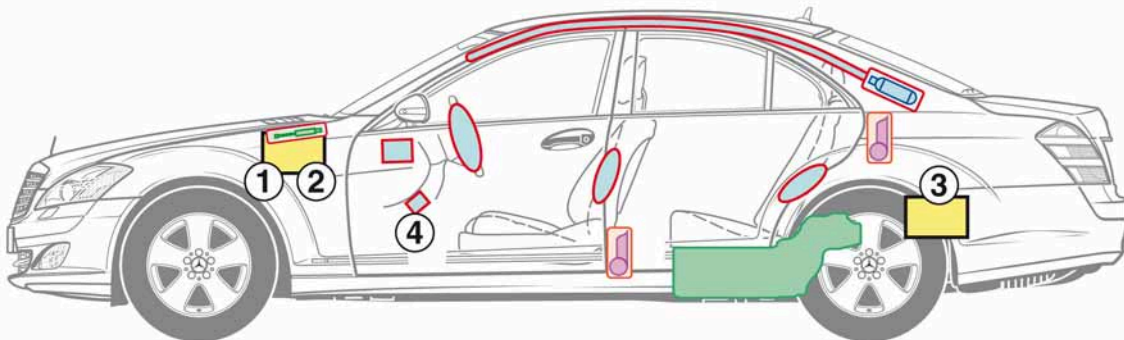
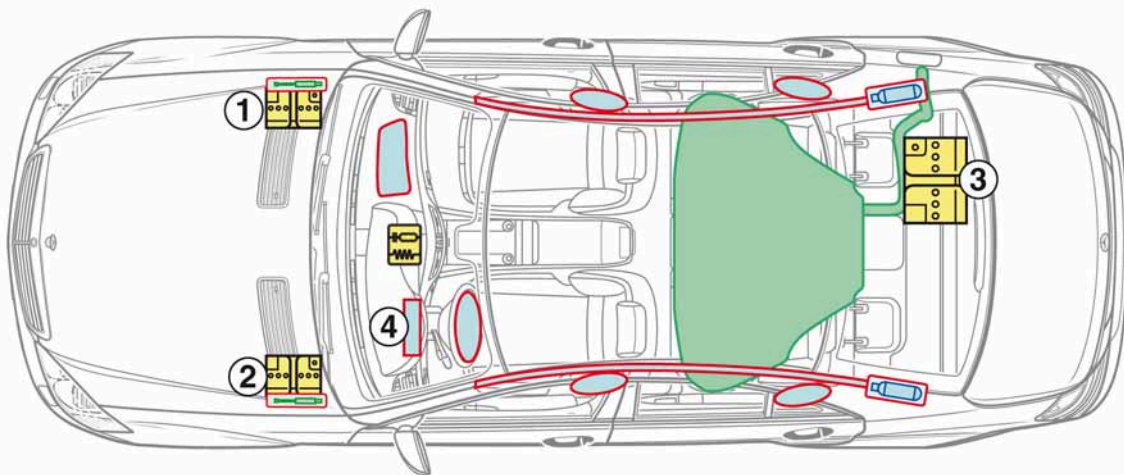





à partir de 2005



1 batterie compartiment moteur, direction à gauche
2 batterie compartiment moteur, direction à droite

3 batterie coffre à bagages (jusqu'à 08.08)
4 Airbag de genoux (à partir de 09.08)

Légende

	Airbag		Renfort de carrosserie		Calculateur
	Générateur de gaz		Arceau de sécurité		Batterie
	Rétracteur de ceinture		Amortisseur à gaz		Réservoir de carburant





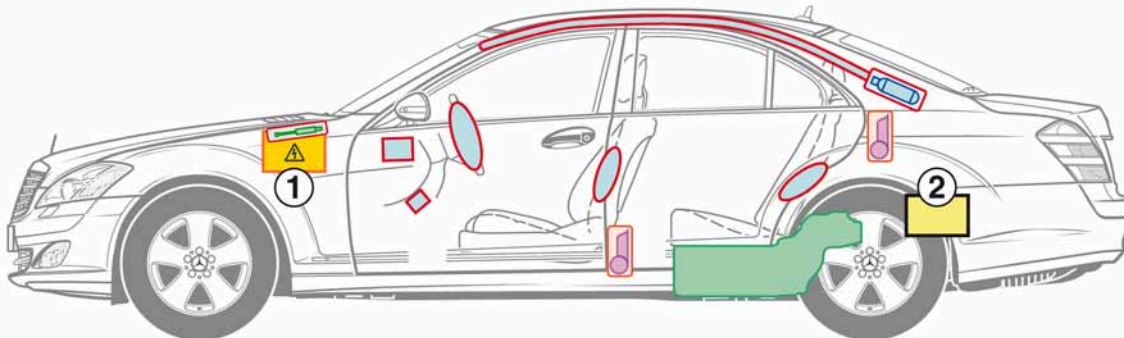
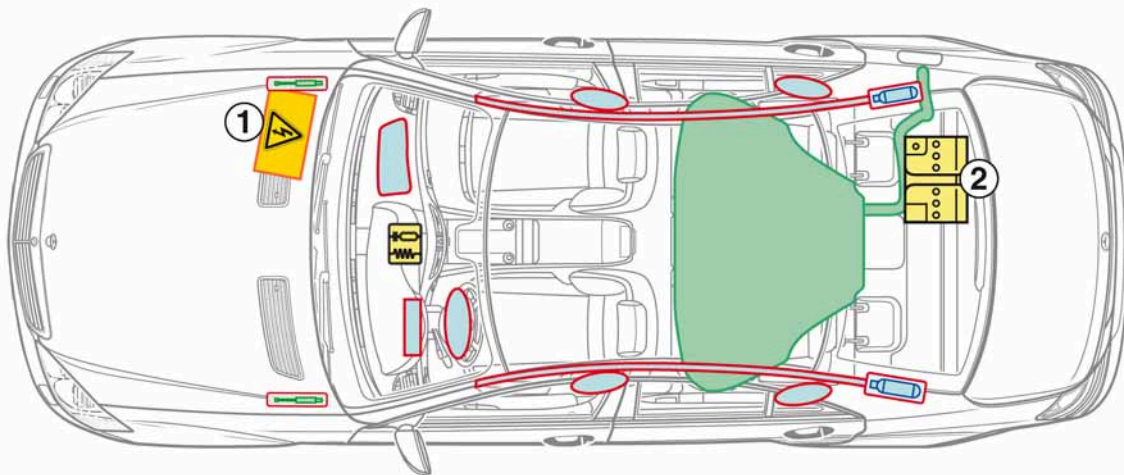

**Classe S
HYBRID
Berline
Type 221**

à partir de 2009

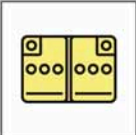
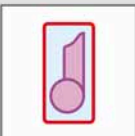
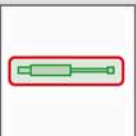

- 1 batterie haute tension compartiment moteur
- 2 batterie du réseau de bord (12 V) coffre à bagages

Légende





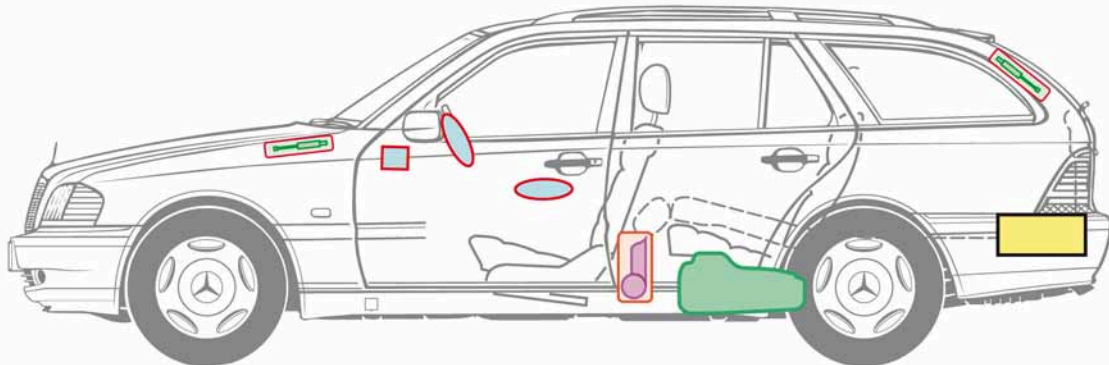
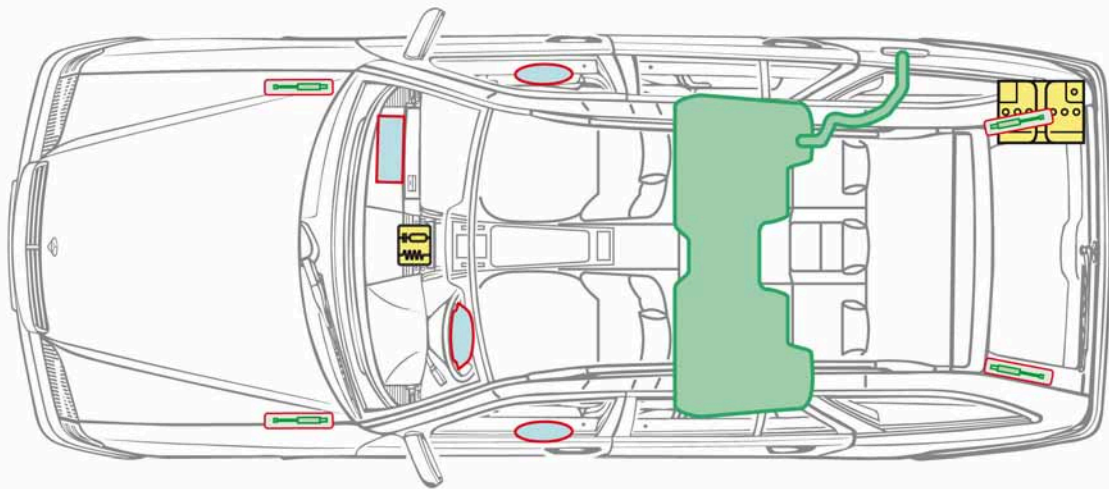

	Airbag		Renfort de carrosserie		Calculateur
	Générateur de gaz		Composants haute tension		Batterie
	Rétracteur de ceinture		Amortisseur à gaz		Réservoir de carburant

**Classe C
Break
Type 202**

1996-2001

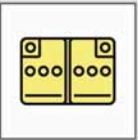
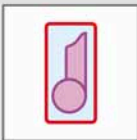
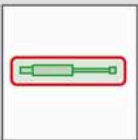

Légende

	Airbag		Renfort de carrosserie		Calculateur
	Générateur de gaz		Arceau de sécurité		Batterie
	Rétracteur de ceinture		Amortisseur à gaz		Réservoir de carburant





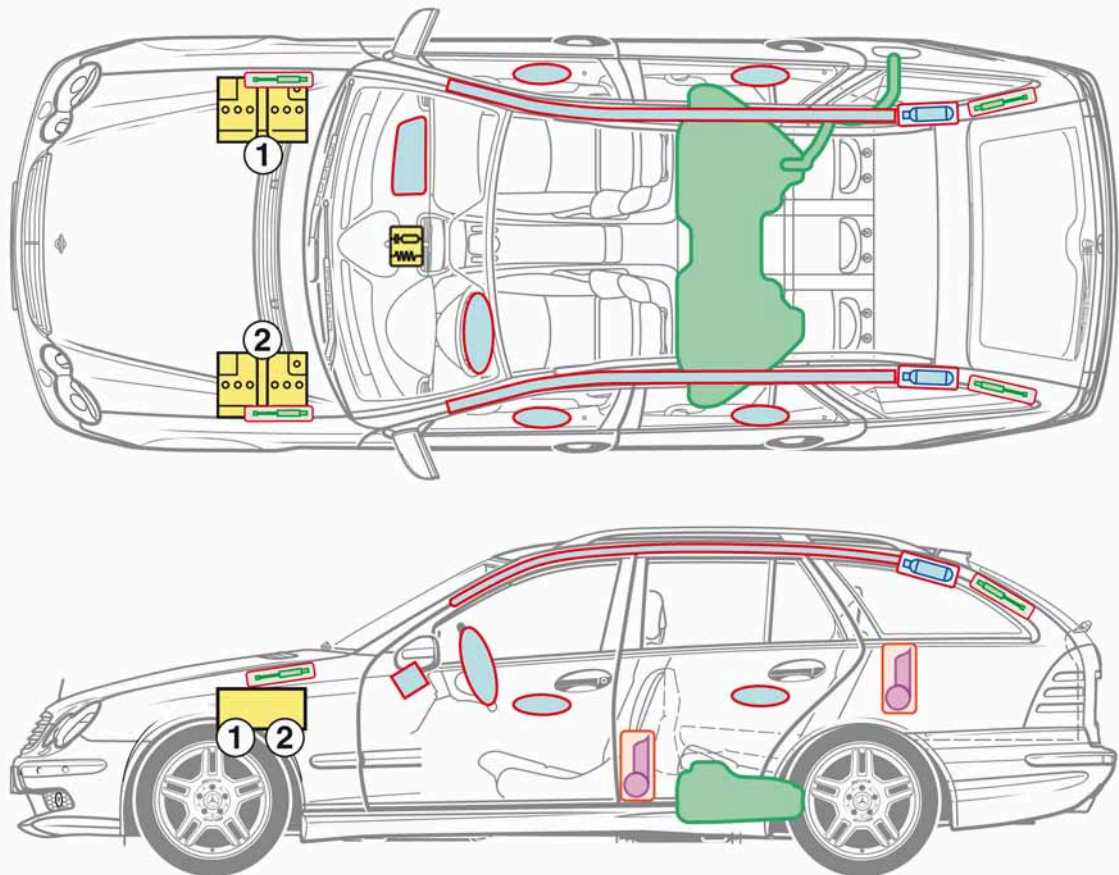

**Classe C
Break
Type 203**

2001-2007

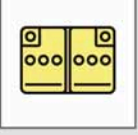
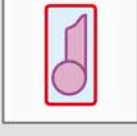
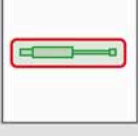

1 direction à gauche
2 direction à droite

Légende

	Airbag		Renfort de carrosserie		Calculateur
	Générateur de gaz		Arceau de sécurité		Batterie
	Rétracteur de ceinture		Amortisseur à gaz		Réservoir de carburant





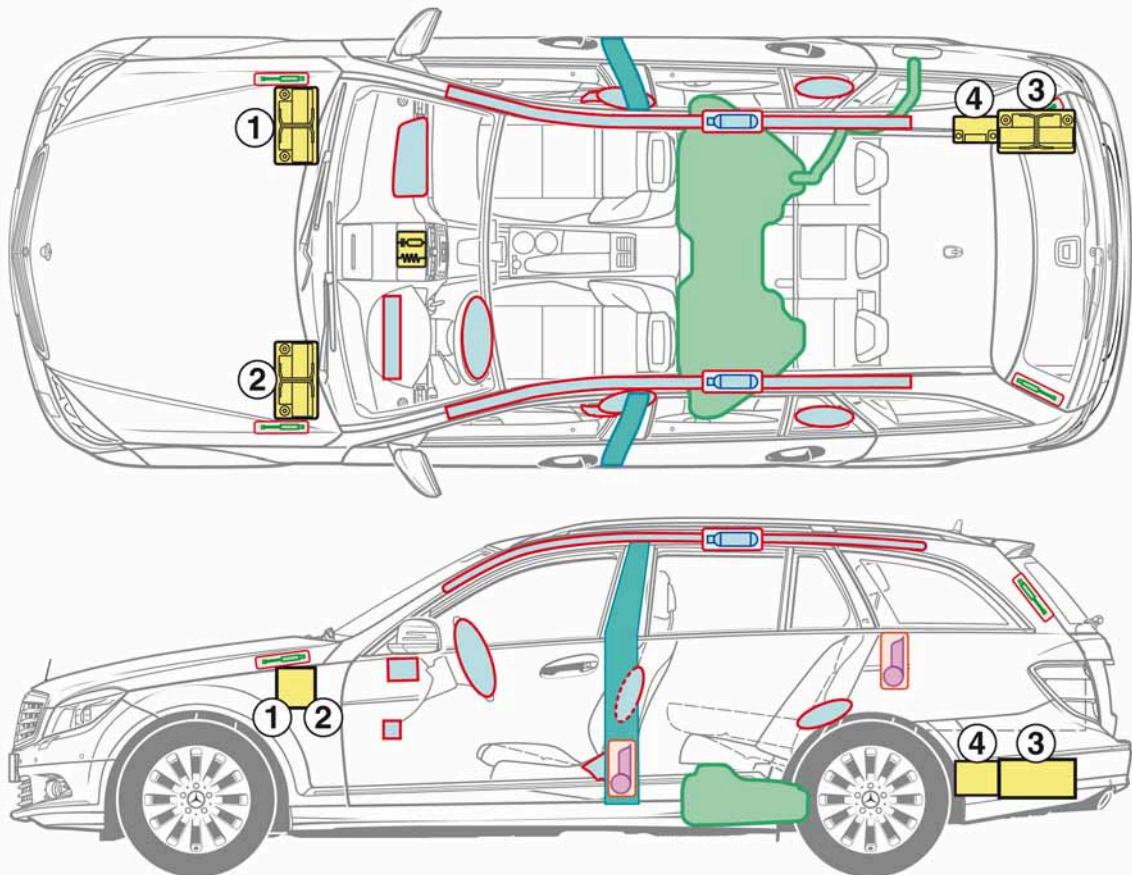



**Classe C
Break
Type 204**

à partir de 2007

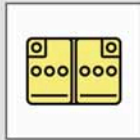

- 1 batterie en véhicules à moteur essence, à partir de 1.12.09 en véhicules à moteur diesel (4- et 8-cyl.) et AMG, dir. à gauche
 2 batterie en véhicules à moteur essence, à partir de 1.12.09 en véhicules à moteur diesel (4- et 8-cyl.) et AMG, dir. à droite
 3 batterie en véhicules à moteur diesel, jusqu'à 30.11.09 en véhicules à moteur diesel (4- et 8-cyl.) et AMG
 4 batterie supplémentaire ECO Start-Stop

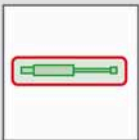
Légende

	Airbag		Renfort de carrosserie		Calculateur
	Générateur de gaz		Arceau de sécurité		Batterie
	Rétracteur de ceinture		Amortisseur à gaz		Réservoir de carburant





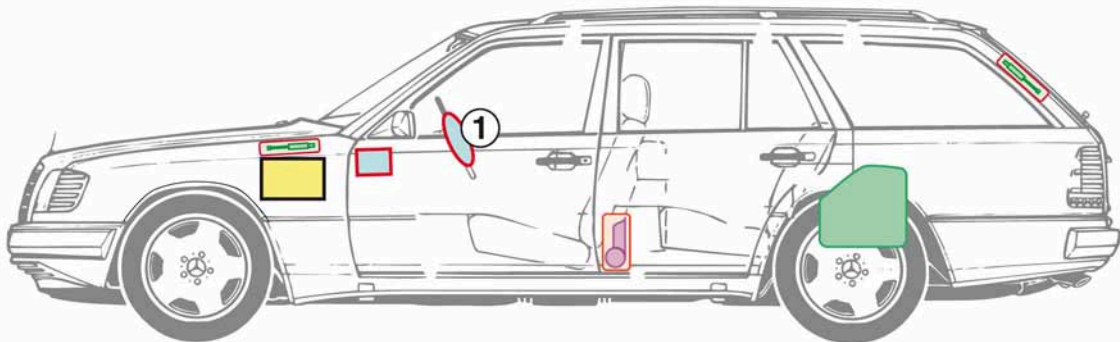
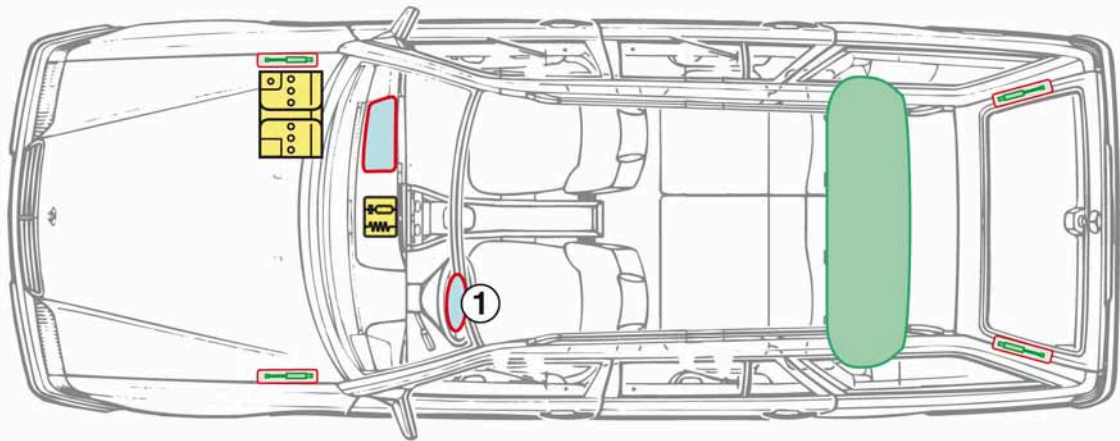



**Classe E
Break
Type 124**

1984-1996

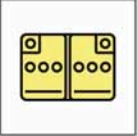

1 Série à partir de 1992

Légende







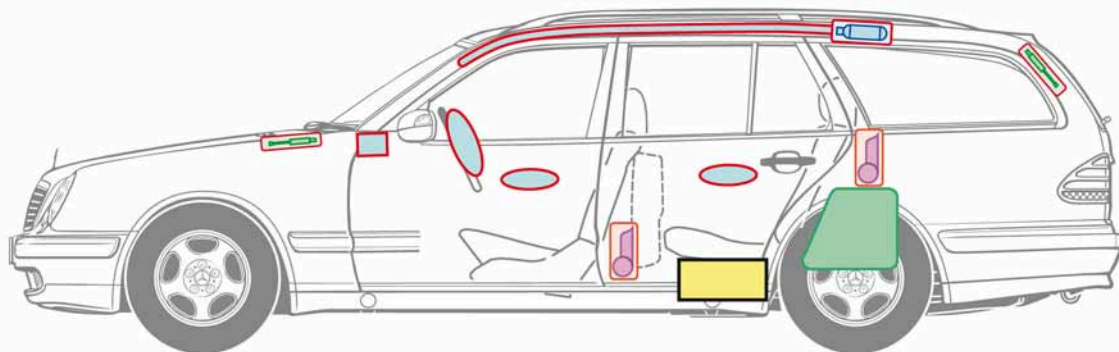
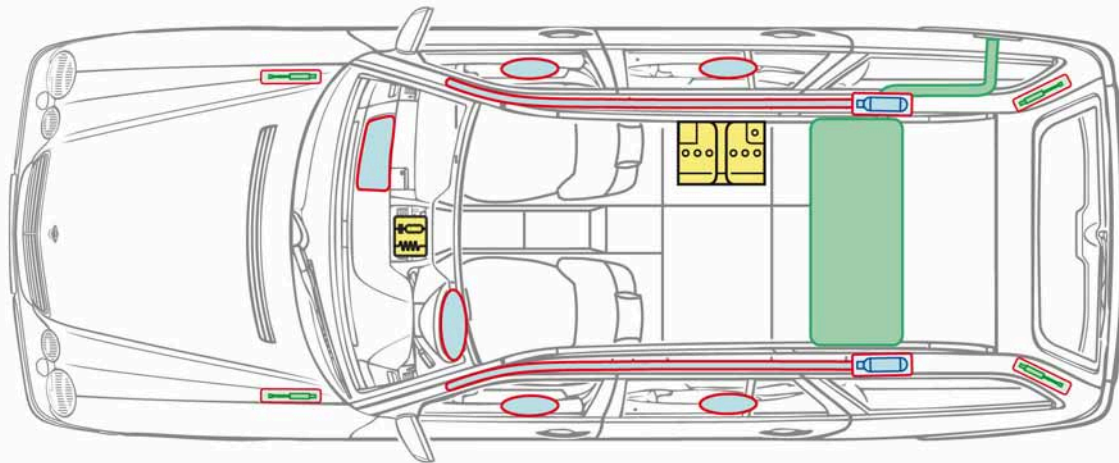

	Airbag		Renfort de carrosserie		Calculateur
	Générateur de gaz		Arceau de sécurité		Batterie
	Rétracteur de ceinture		Amortisseur à gaz		Réservoir de carburant

**Classe E
Break
Type 210**

1996-2003

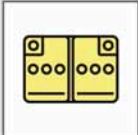

Légende

	Airbag		Renfort de carrosserie		Calculateur
	Générateur de gaz		Arceau de sécurité		Batterie
	Rétracteur de ceinture		Amortisseur à gaz		Réservoir de carburant

**Classe E
Break
Type 211**



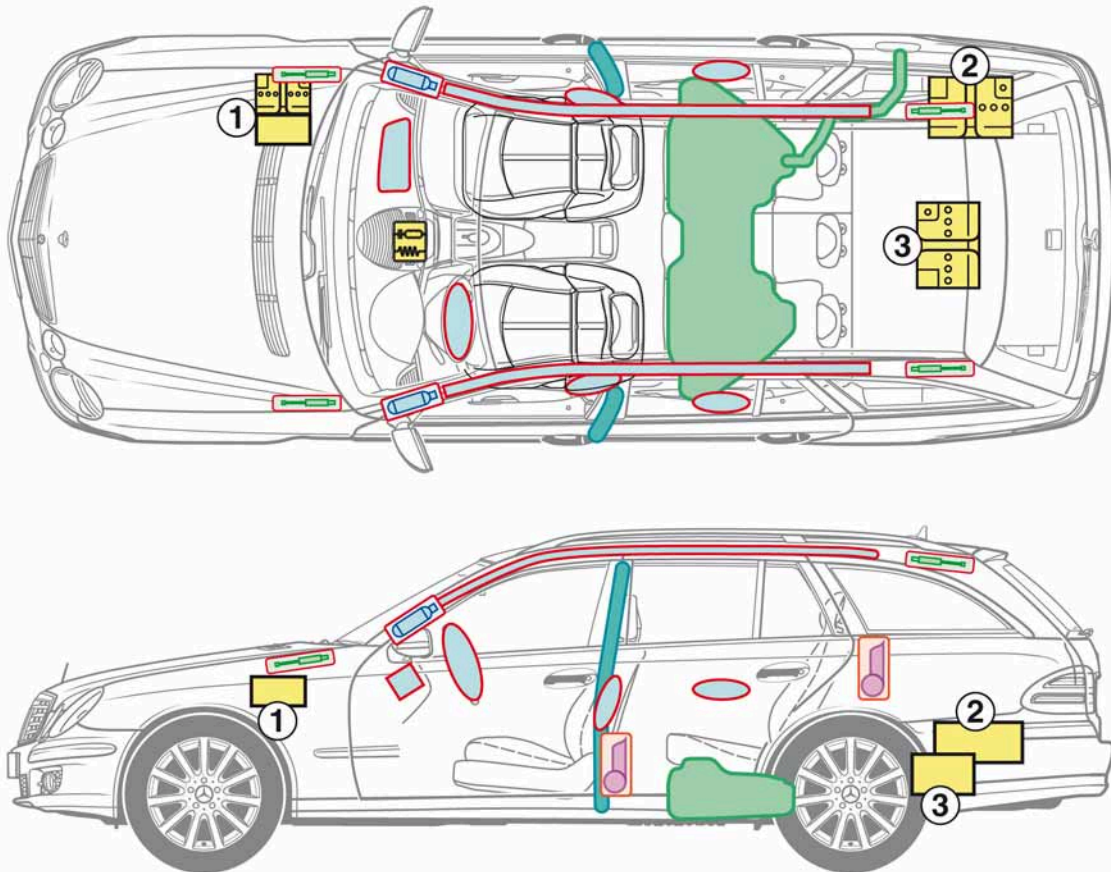





2003-2009

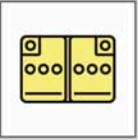

1 batterie additionnelle compartiment moteur
2 batterie principale coffre à bagages
(équipement avec roue de secours)

3 batterie principale coffre à bagages
(équipement sans roue de secours)

Légende

	Airbag		Renfort de carrosserie		Calculateur
	Générateur de gaz		Arceau de sécurité		Batterie
	Rétracteur de ceinture		Amortisseur à gaz		Réservoir de carburant

**Classe E
Break
Type 212**



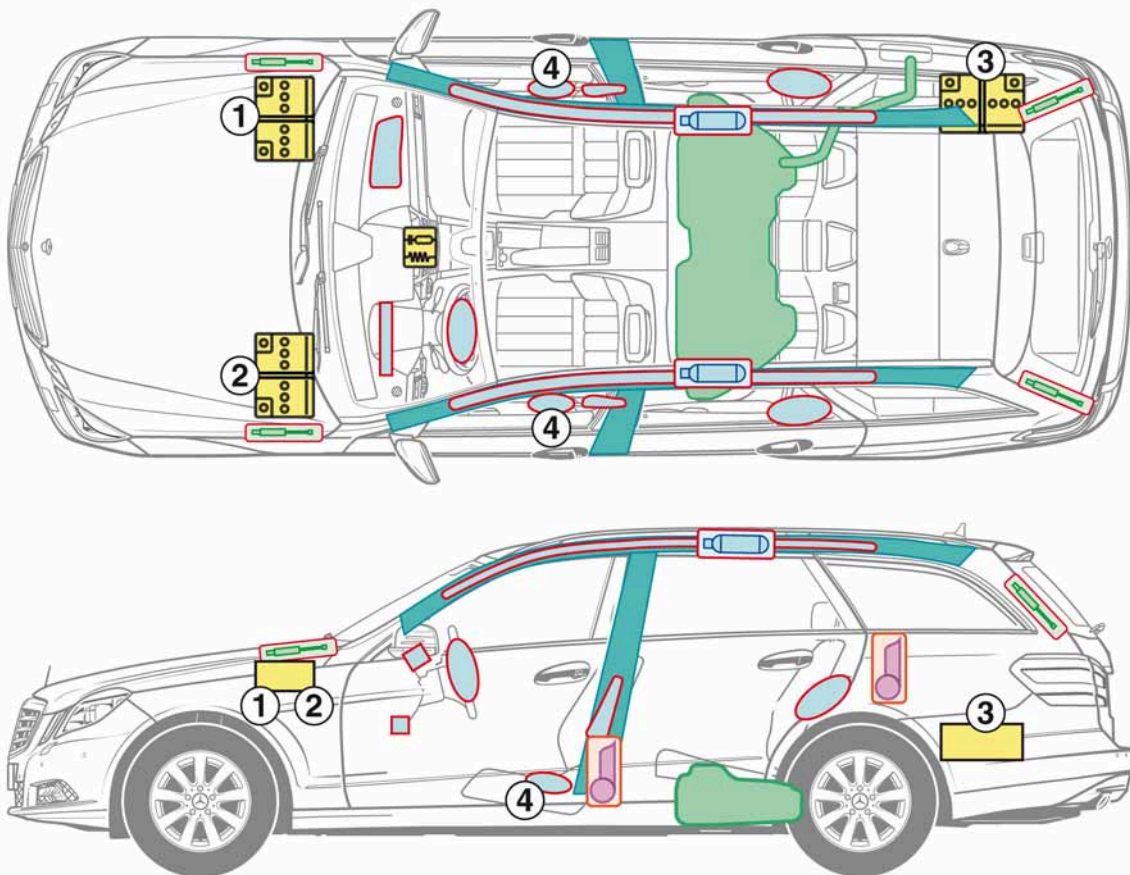





à partir de 2009



1 avec moteur 4 et 6 cylindres, direction à gauche
2 avec moteur 4 et 6 cylindres, direction à droite

3 avec moteur 8 cylindres
4 airbag pelvien (à partir de 06.2009)

Légende

	Airbag		Renfort de carrosserie		Calculateur
	Générateur de gaz		Arceau de sécurité		Batterie
	Rétracteur de ceinture		Amortisseur à gaz		Réservoir de carburant





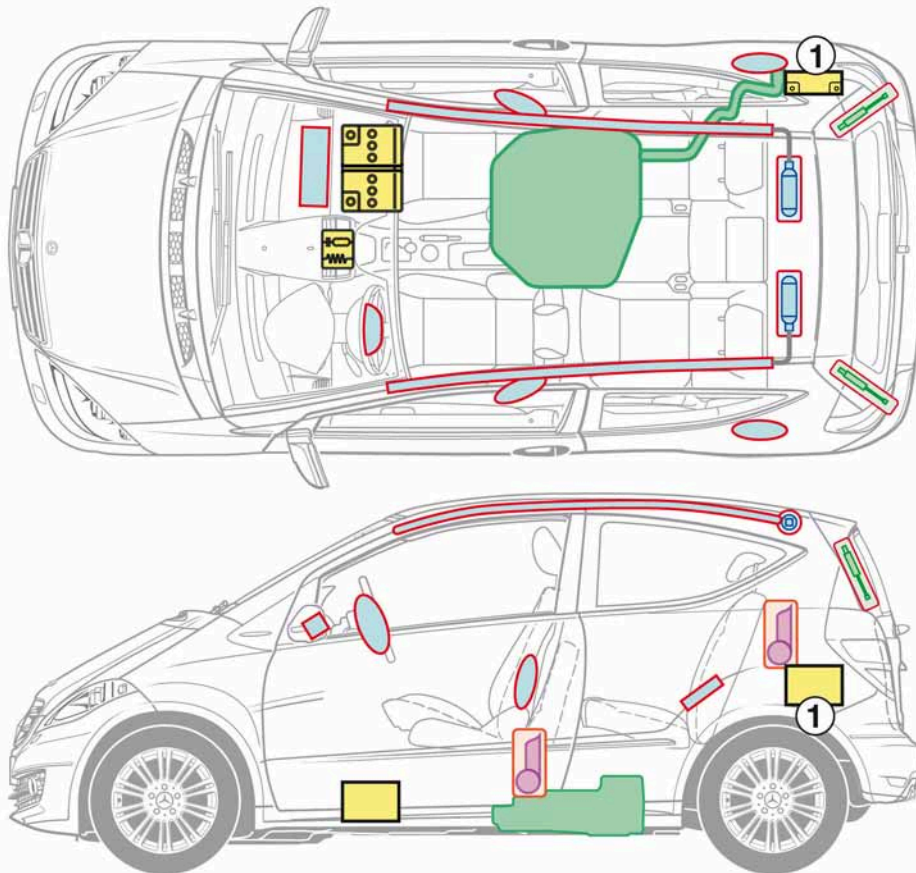



**Classe A
Coupé
Type 169**

à partir de 2004

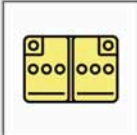

1 batterie additionnelle sur les modèles BlueEFFICIENCY

Légende

	Airbag		Renfort de carrosserie		Calculateur
	Générateur de gaz		Arceau de sécurité		Batterie
	Rétracteur de ceinture		Amortisseur à gaz		Réservoir de carburant





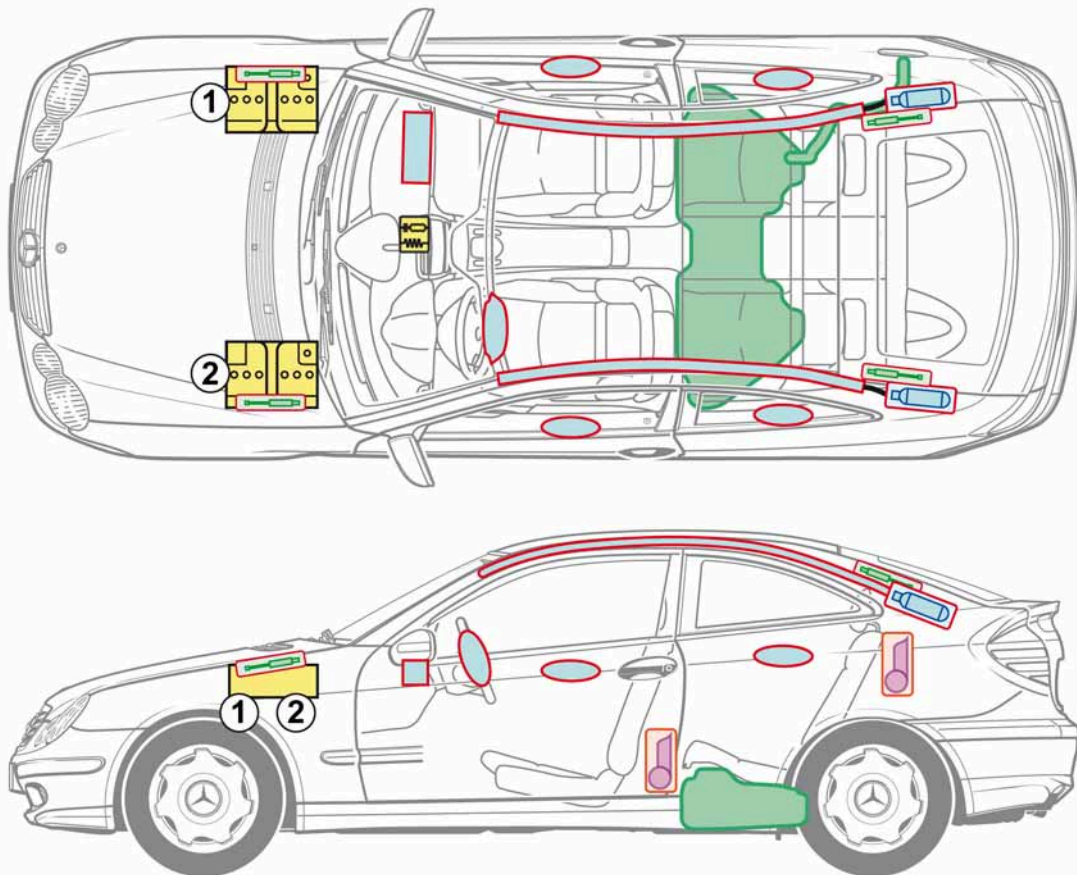

**Classe C
Coupé Sport
Type 203**

2000-2008

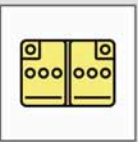
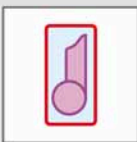
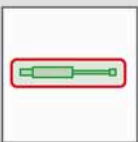

1 direction à gauche
2 direction à droite

Légende

	Airbag		Renfort de carrosserie		Calculateur
	Générateur de gaz		Arceau de sécurité		Batterie
	Rétracteur de ceinture		Amortisseur à gaz		Réservoir de carburant

**Classe C
Coupé
Type 204**



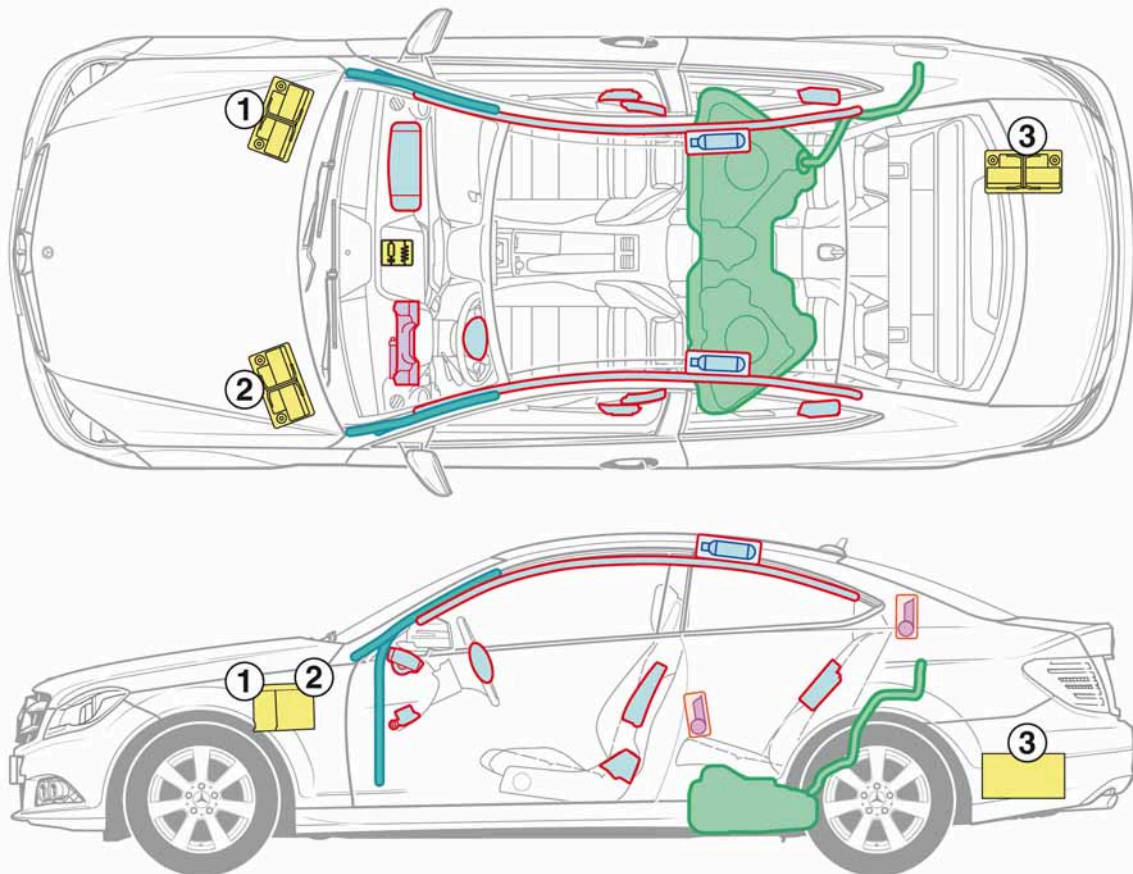





à partir de 2011



1 batterie du réseau de bord, direction à gauche
2 batterie du réseau de bord, direction à droite

3 batterie additionnelle

Légende

	Airbag		Renfort de carrosserie		Calculateur
	Générateur de gaz		Arceau de sécurité		Batterie
	Rétracteur de ceinture		Amortisseur à gaz		Réservoir de carburant





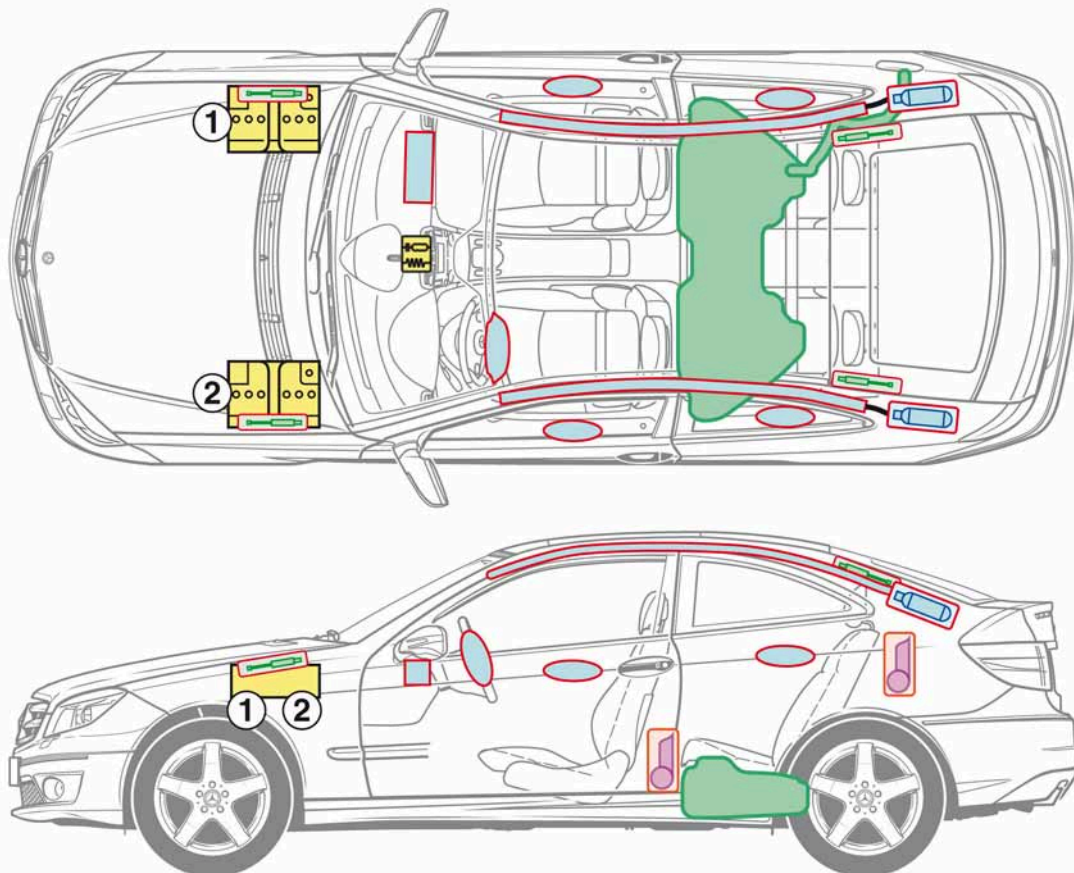



**Classe CLC
Coupé
Type 203**

à partir de 2008

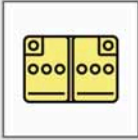

1 direction à gauche
2 direction à droite

Légende







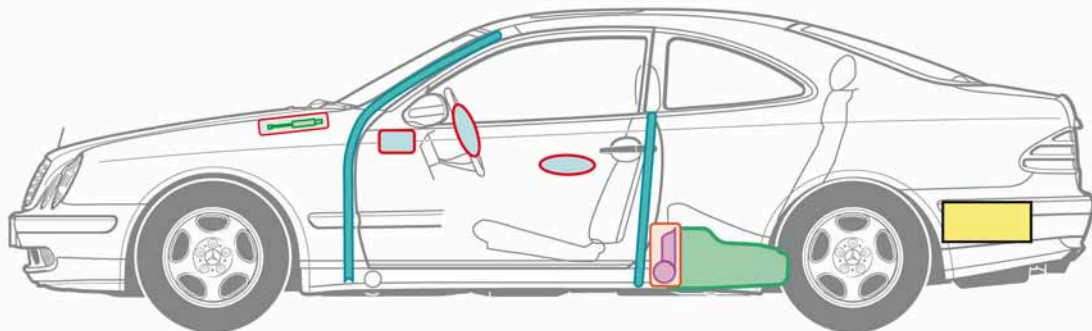
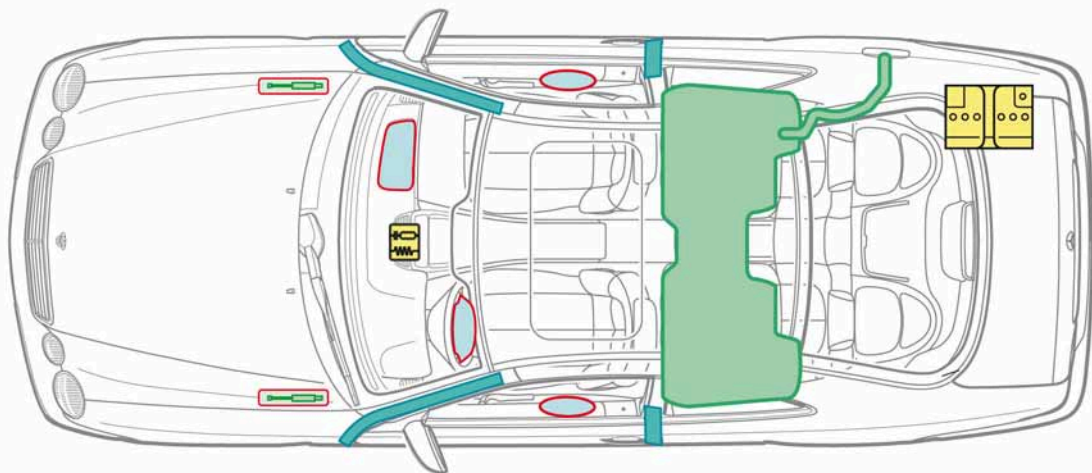

	Airbag		Renfort de carrosserie		Calculateur
	Générateur de gaz		Arceau de sécurité		Batterie
	Rétracteur de ceinture		Amortisseur à gaz		Réservoir de carburant

Classe CLK
Coupé
Type 208

1997-2002

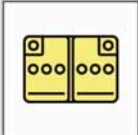

Légende

	Airbag		Renfort de carrosserie		Calculateur
	Générateur de gaz		Arceau de sécurité		Batterie
	Rétracteur de ceinture		Amortisseur à gaz		Réservoir de carburant





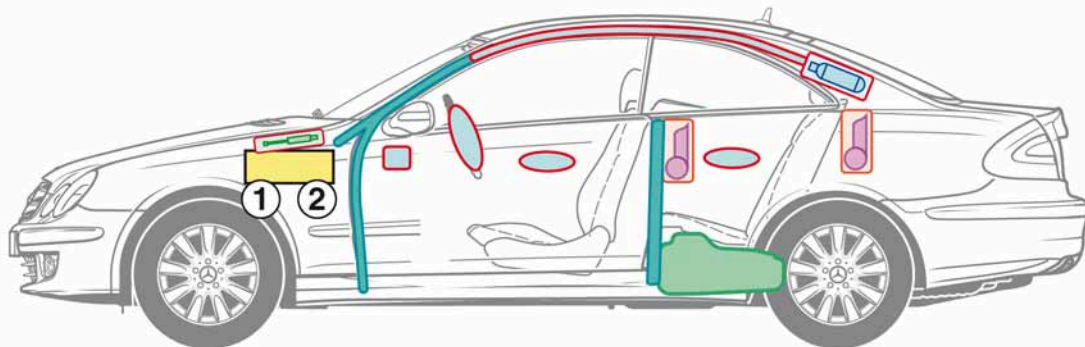
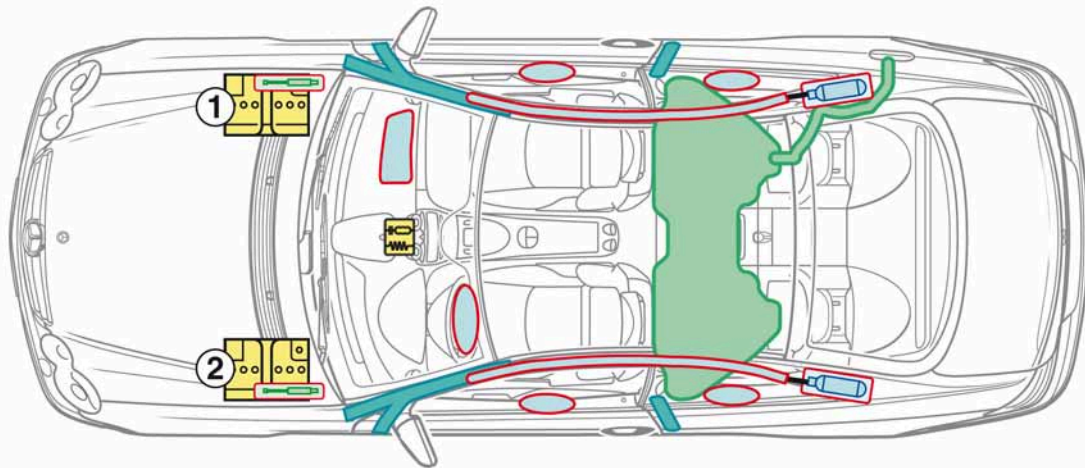

**Classe CLK
Coupé
Type 209**

2002-2009

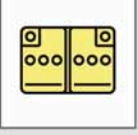
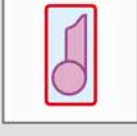
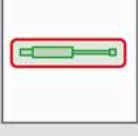

1 direction à gauche
2 direction à droite

Légende







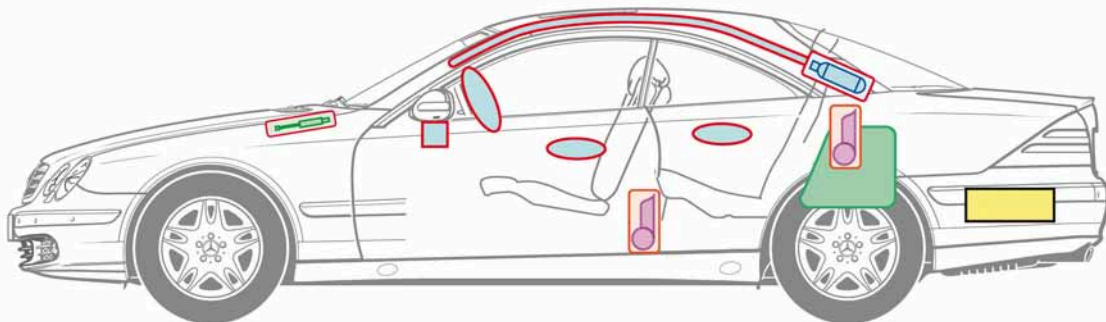
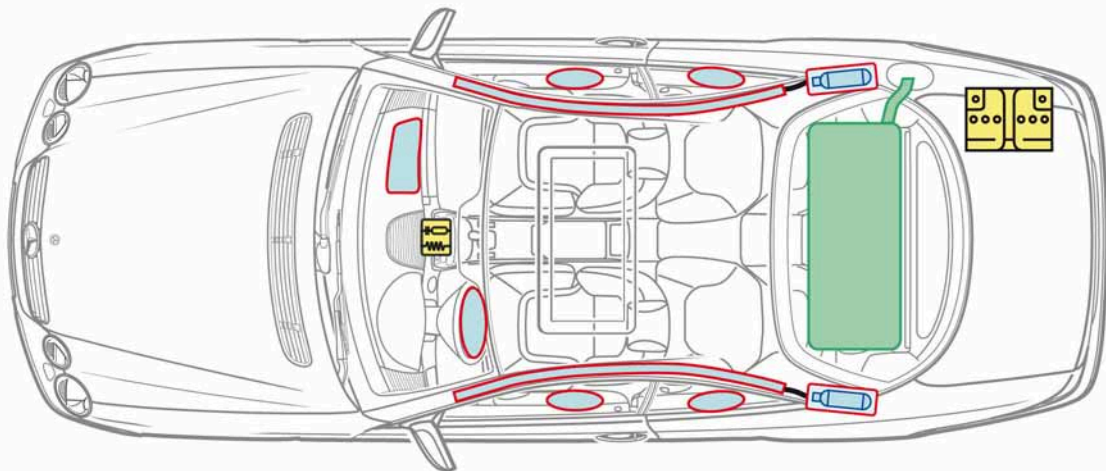

	Airbag		Renfort de carrosserie		Calculateur
	Générateur de gaz		Arceau de sécurité		Batterie
	Rétracteur de ceinture		Amortisseur à gaz		Réservoir de carburant

Classe CL
Coupé
Type 215

1999-2006

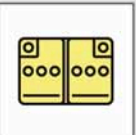

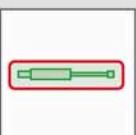
Légende

	Airbag		Renfort de carrosserie		Calculateur
	Générateur de gaz		Arceau de sécurité		Batterie
	Rétracteur de ceinture		Amortisseur à gaz		Réservoir de carburant





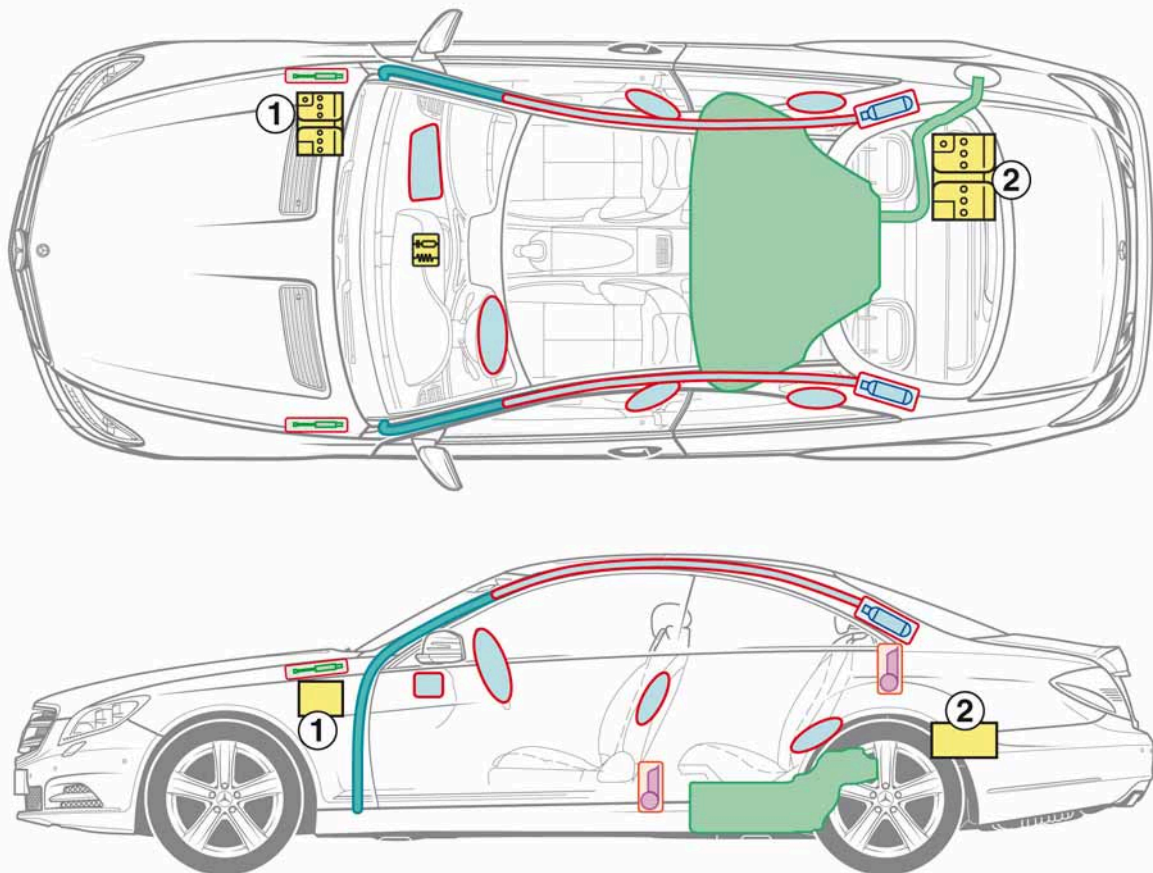



**Classe CL
Coupé
Type 216**

à partir de 2006

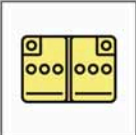

- 1 batterie de démarrage compartiment moteur
2 batterie du réseau de bord coffre à bagages

Légende

	Airbag		Renfort de carrosserie		Calculateur
	Générateur de gaz		Arceau de sécurité		Batterie
	Rétracteur de ceinture		Amortisseur à gaz		Réservoir de carburant

**Classe CLS
Coupé
Type 219**



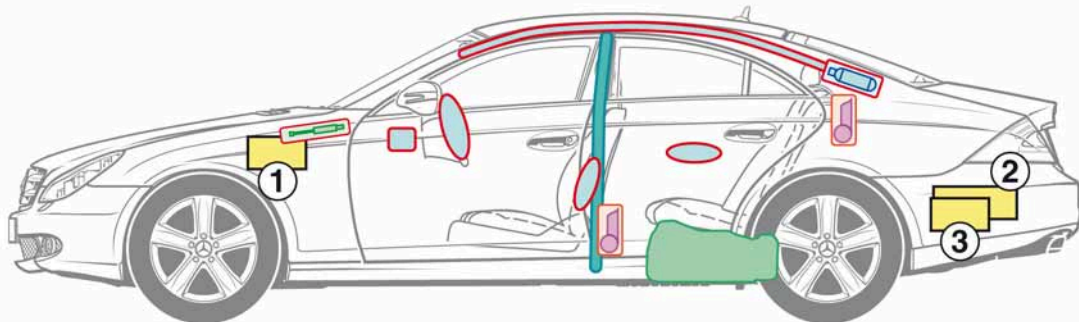
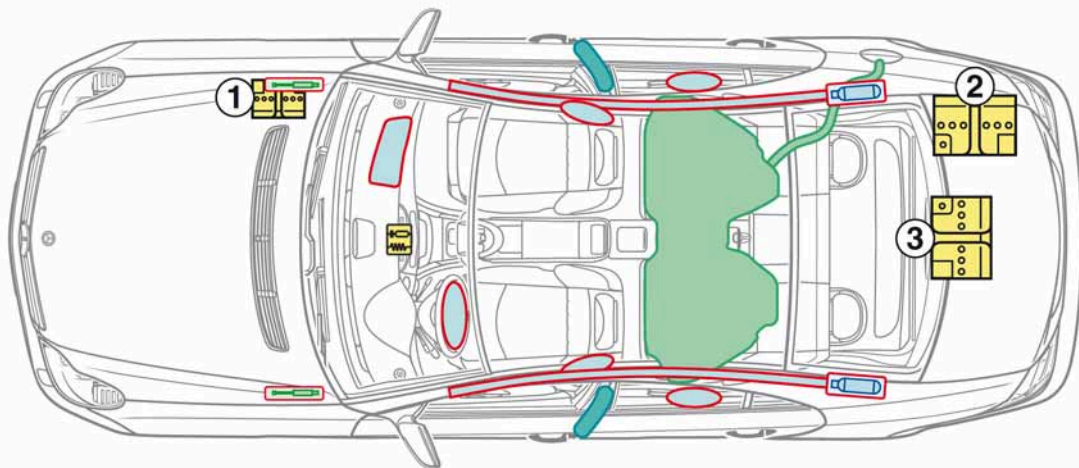





2004-2009



1 batterie additionnelle compartiment moteur
2 batterie principale coffre à bagages (avec équipement comprenant la roue de secours)

3 batterie principale coffre à bagages (avec équipement sans roue de secours)

Légende

	Airbag		Renfort de carrosserie		Calculateur
	Générateur de gaz		Arceau de sécurité		Batterie
	Rétracteur de ceinture		Amortisseur à gaz		Réservoir de carburant





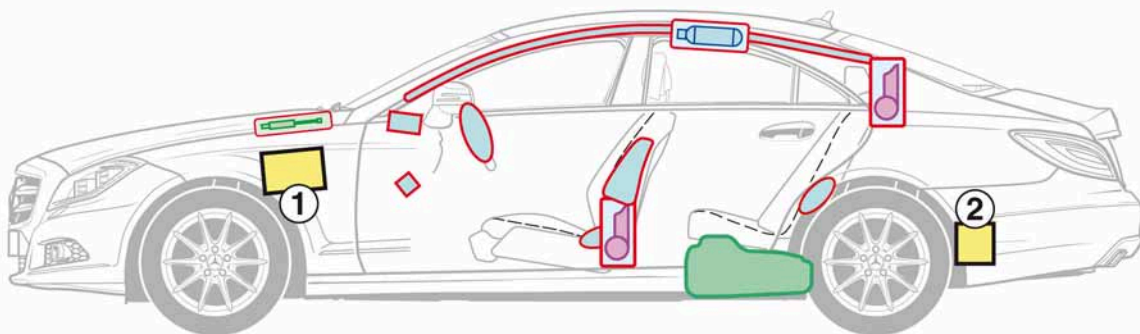
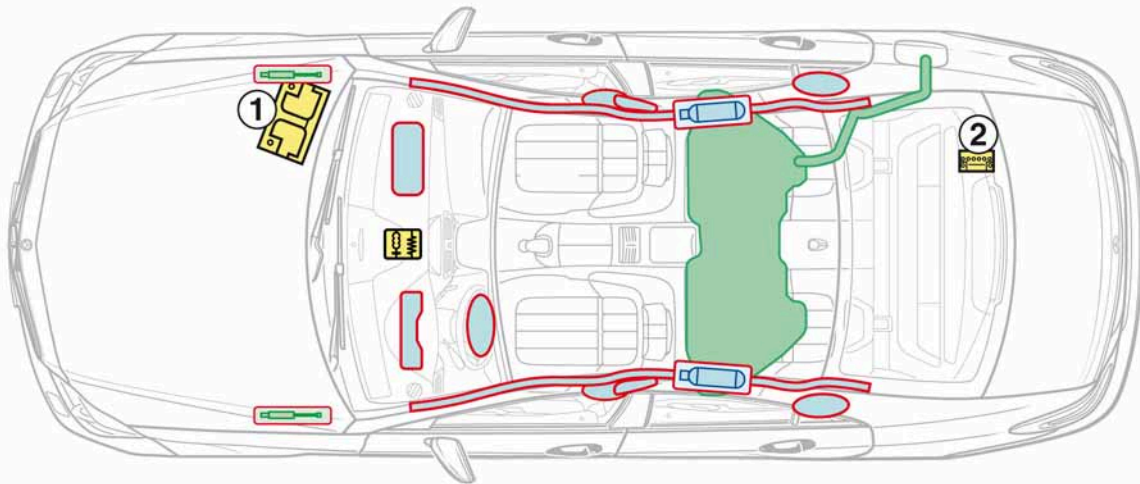



**Classe CLS
Coupé
Type 218**

à partir de 2010

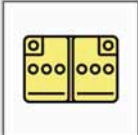

- 1 batterie du réseau de bord
- 2 batterie additionnelle

Légende

	Airbag		Renfort de carrosserie		Calculateur
	Générateur de gaz		Arceau de sécurité		Batterie
	Rétracteur de ceinture		Amortisseur à gaz		Réservoir de carburant





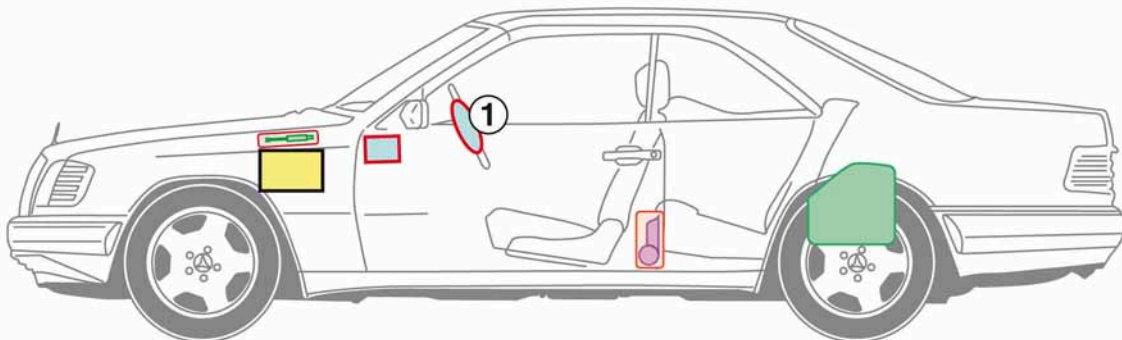
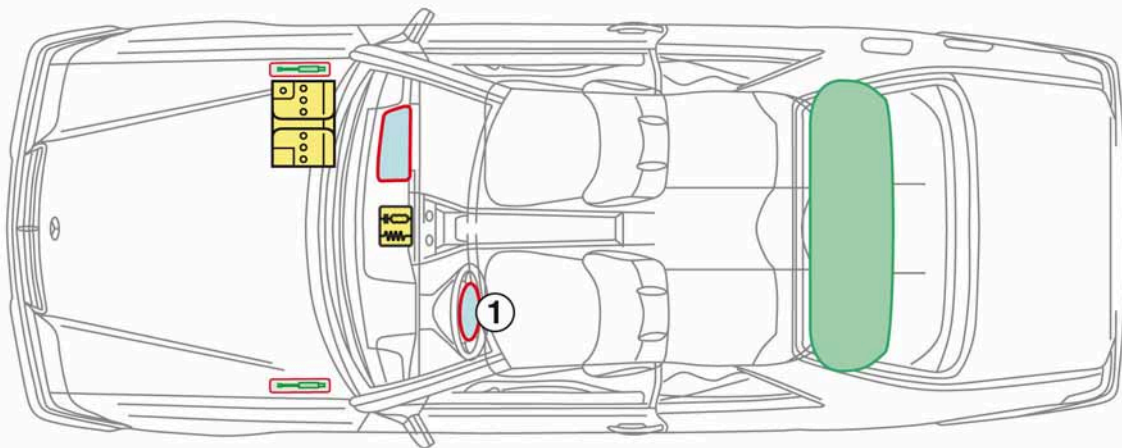

**Classe E
Coupé
Type 124**

1987-1997

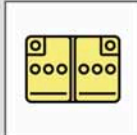
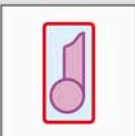
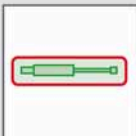

1 Série à partir de 1992

Légende

	Airbag		Renfort de carrosserie		Calculateur
	Générateur de gaz		Arceau de sécurité		Batterie
	Rétracteur de ceinture		Amortisseur à gaz		Réservoir de carburant

**Classe E
Coupé
Type 207**



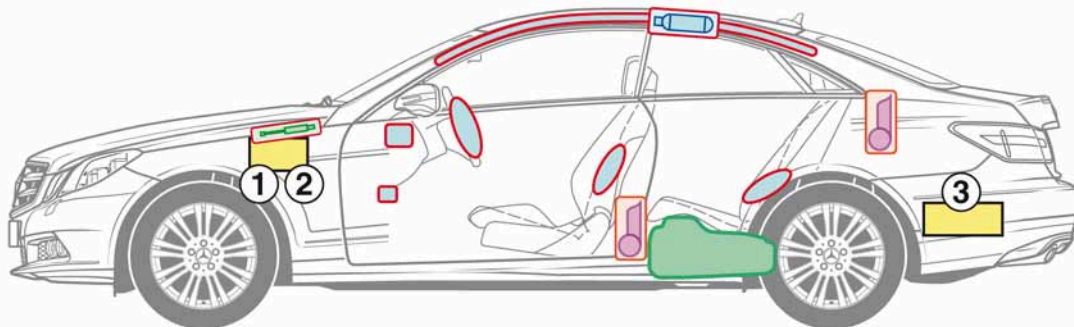
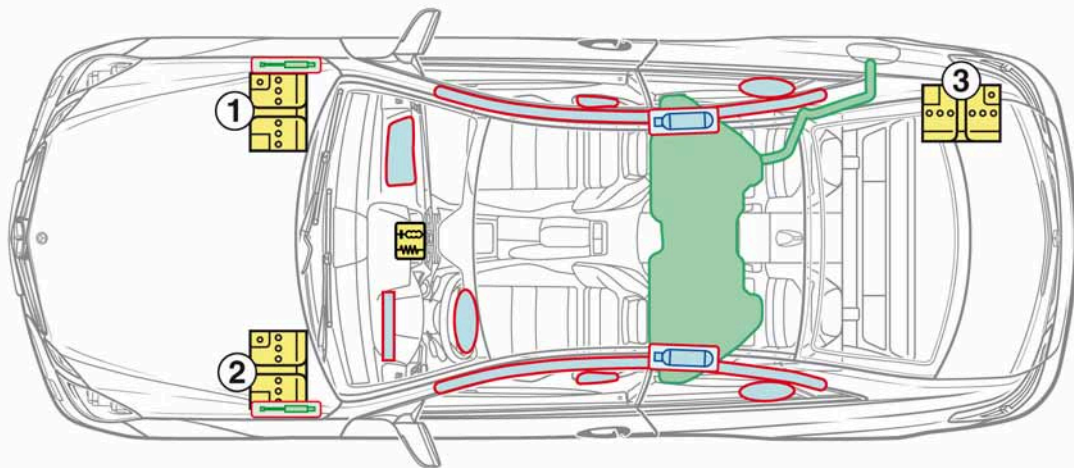





à partir de 2009

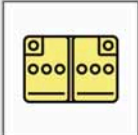

1 batterie du réseau de bord, direction à gauche
2 batterie du réseau de bord, direction à droite

3 batterie additionnelle ECO Start-Stop

Légende





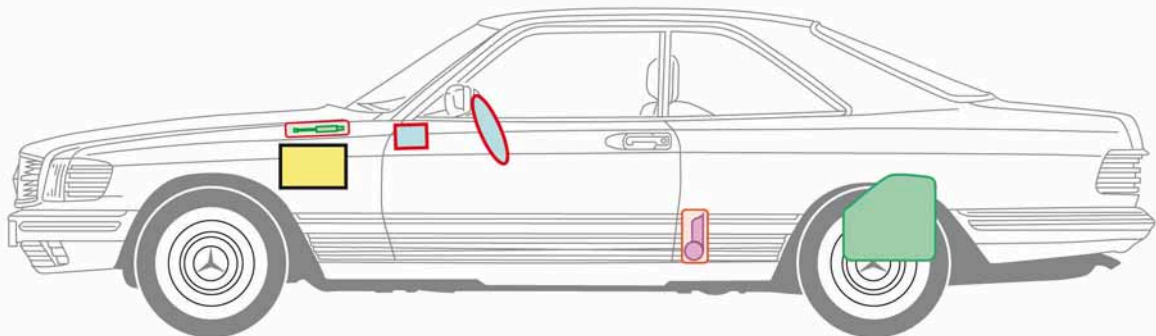
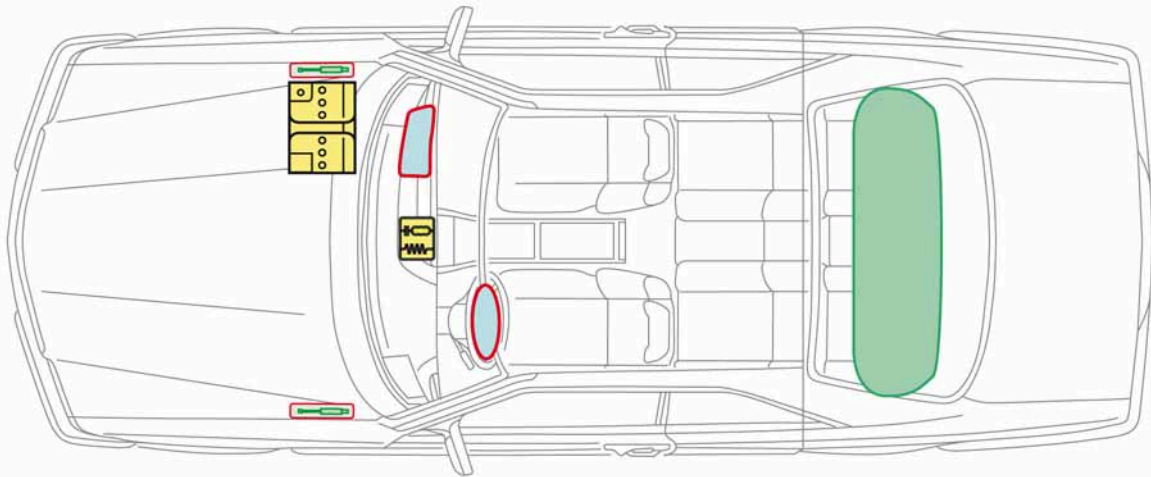

	Airbag		Renfort de carrosserie		Calculateur
	Générateur de gaz		Arceau de sécurité		Batterie
	Rétracteur de ceinture		Amortisseur à gaz		Réservoir de carburant

**Classe S
Coupé
Type 126**

1981-1991

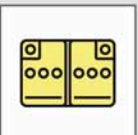
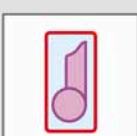
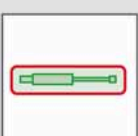

Légende

	Airbag		Renfort de carrosserie		Calculateur
	Générateur de gaz		Arceau de sécurité		Batterie
	Rétracteur de ceinture		Amortisseur à gaz		Réservoir de carburant





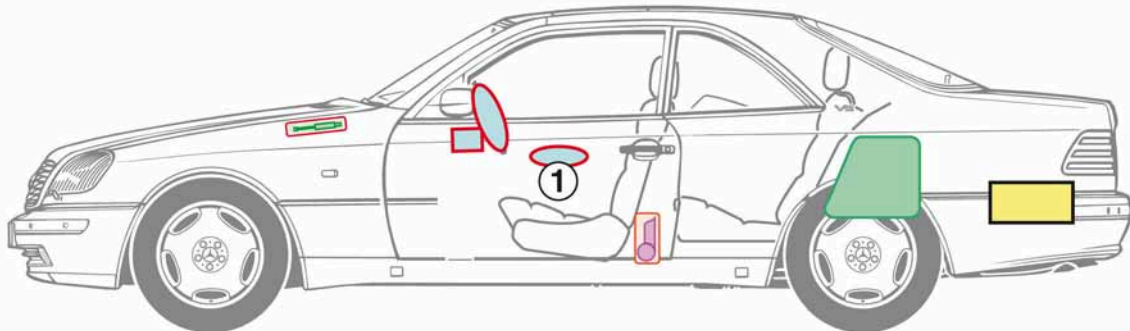
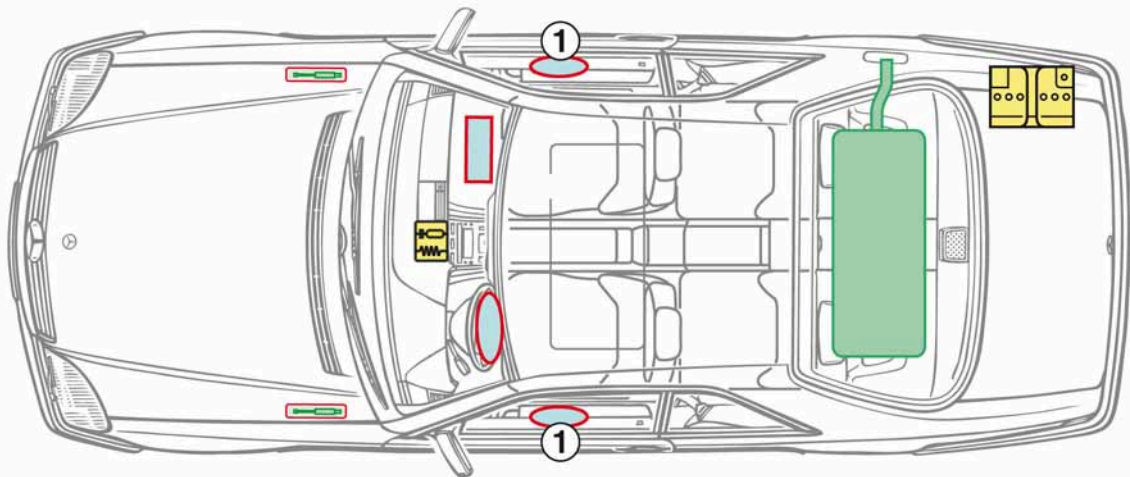

**Classe S
Coupé
Type 140**

1992-1998

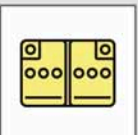
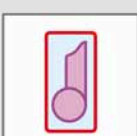
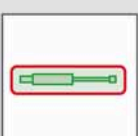

1 option

Légende







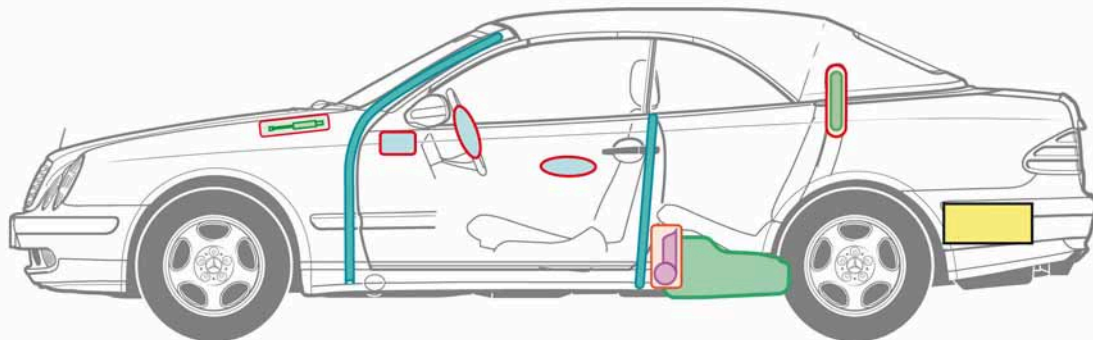
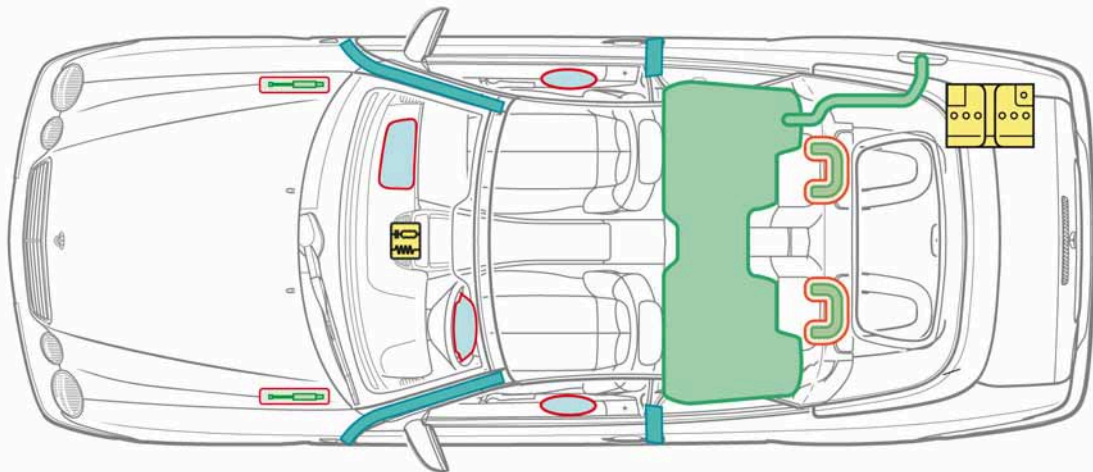

	Airbag		Renfort de carrosserie		Calculateur
	Générateur de gaz		Arceau de sécurité		Batterie
	Rétracteur de ceinture		Amortisseur à gaz		Réservoir de carburant

Classe CLK
Cabrio
Type 208

1997-2002

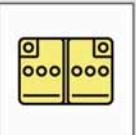

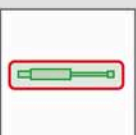
Légende

	Airbag		Renfort de carrosserie		Calculateur
	Générateur de gaz		Arceau de sécurité		Batterie
	Rétracteur de ceinture		Amortisseur à gaz		Réservoir de carburant





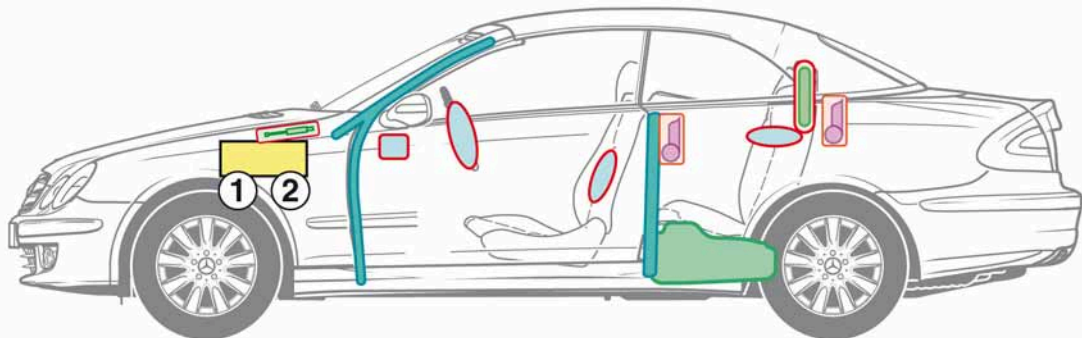
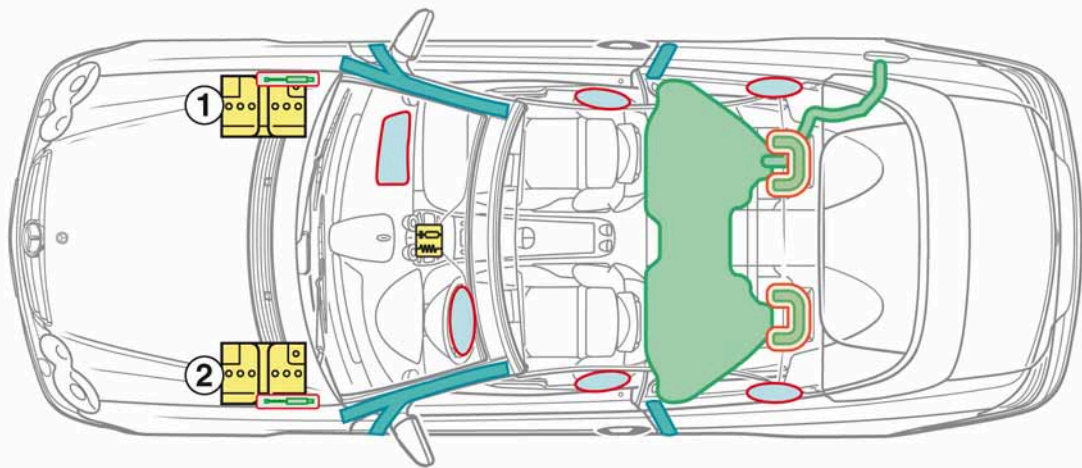



**Classe CLK
Cabrio
Type 209**

2003-2009

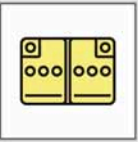

1 direction à gauche
2 direction à droite

Légende







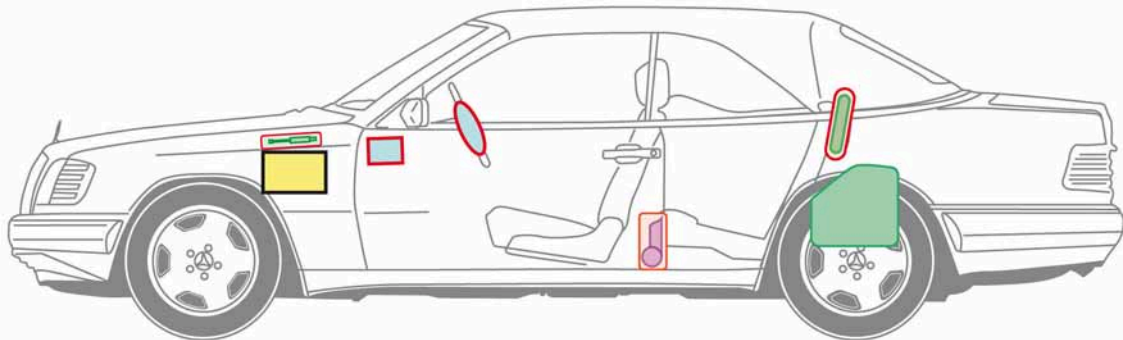
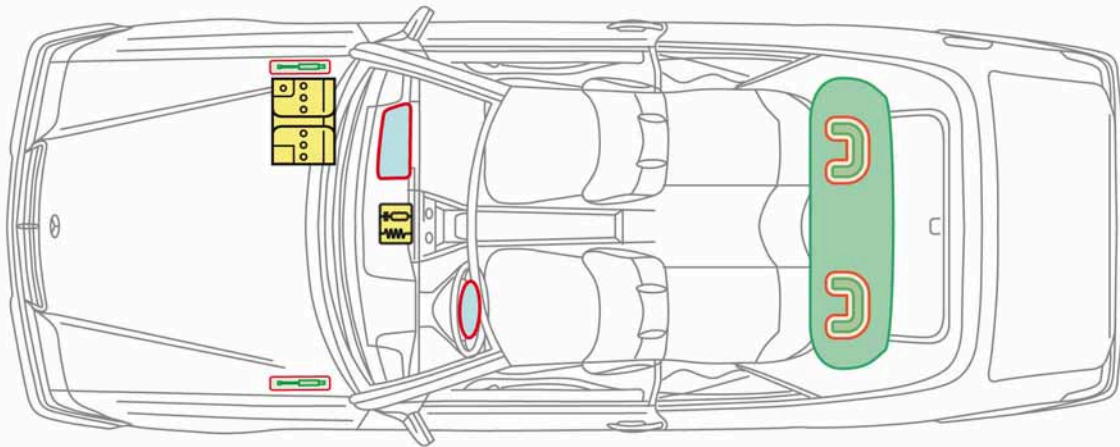

	Airbag		Renfort de carrosserie		Calculateur
	Générateur de gaz		Arceau de sécurité		Batterie
	Rétracteur de ceinture		Amortisseur à gaz		Réservoir de carburant

**Classe E
Cabrio
Type 124**

1987-1997

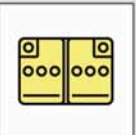

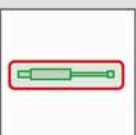
Légende

	Airbag		Renfort de carrosserie		Calculateur
	Générateur de gaz		Arceau de sécurité		Batterie
	Rétracteur de ceinture		Amortisseur à gaz		Réservoir de carburant

**Classe E
Cabrio
Type 207**



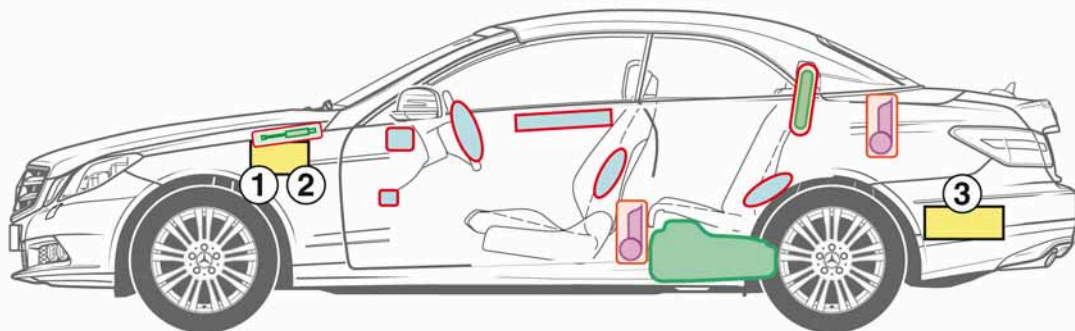
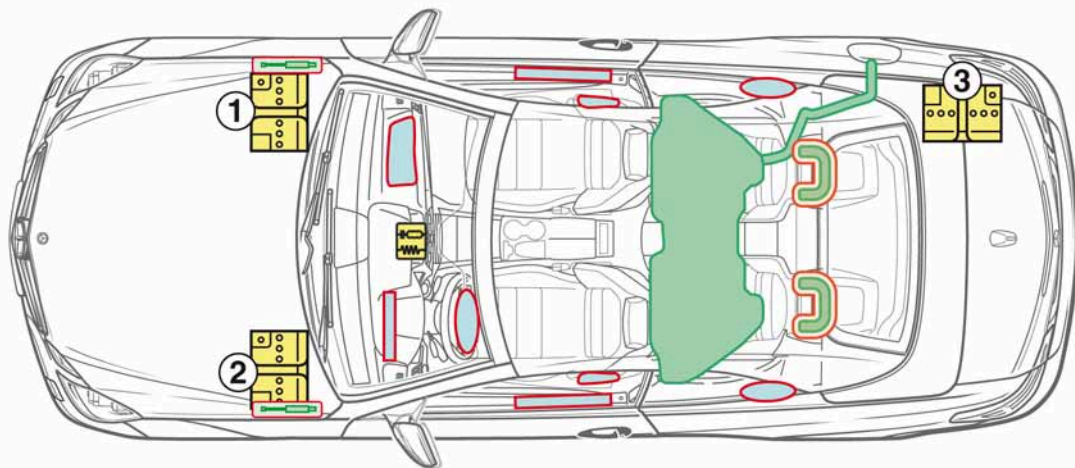





à partir de 2010

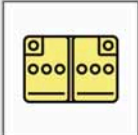

1 batterie du réseau de bord, direction à gauche
2 batterie du réseau de bord, direction à droite

3 batterie additionnelle ECO Start-Stop

Légende

	Airbag		Renfort de carrosserie		Calculateur
	Générateur de gaz		Arceau de sécurité		Batterie
	Rétracteur de ceinture		Amortisseur à gaz		Réservoir de carburant





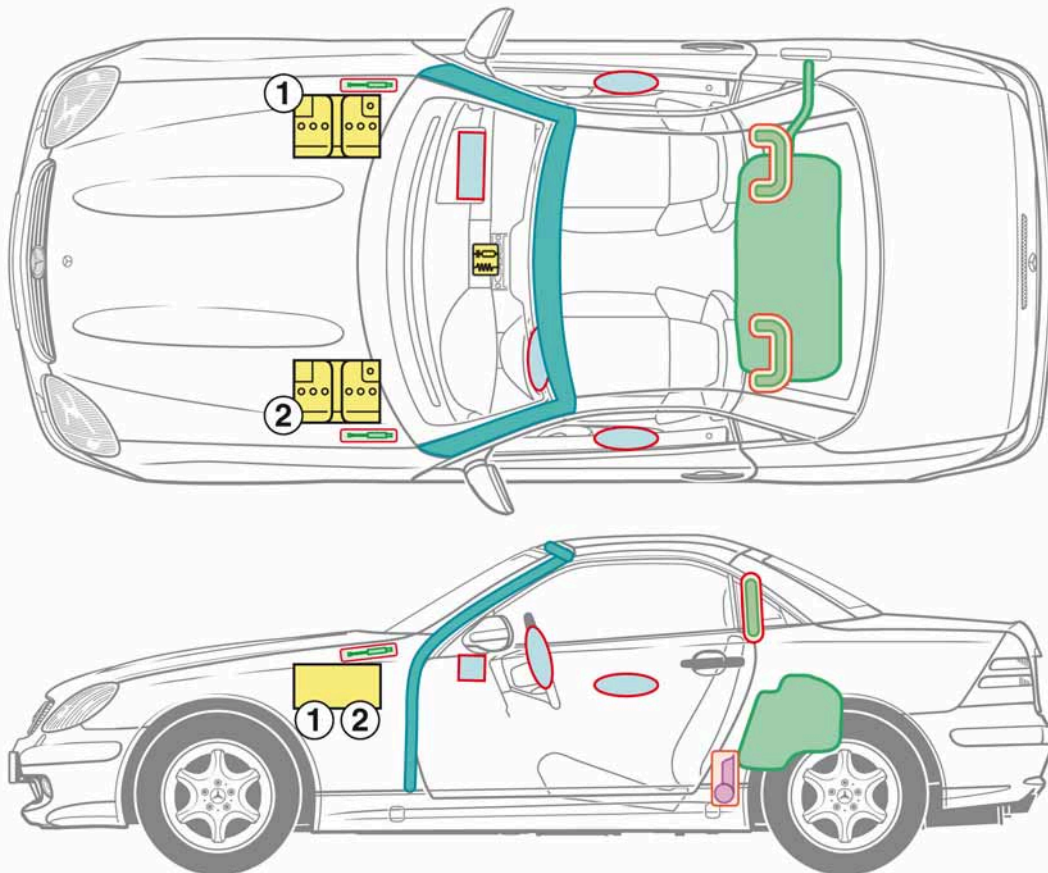



**Classe SLK
Roadster
Type 170**

1996-2004

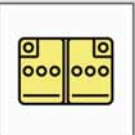

1 direction à gauche
2 direction à droite

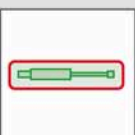
Légende

	Airbag		Renfort de carrosserie		Calculateur
	Générateur de gaz		Arceau de sécurité		Batterie
	Rétracteur de ceinture		Amortisseur à gaz		Réservoir de carburant





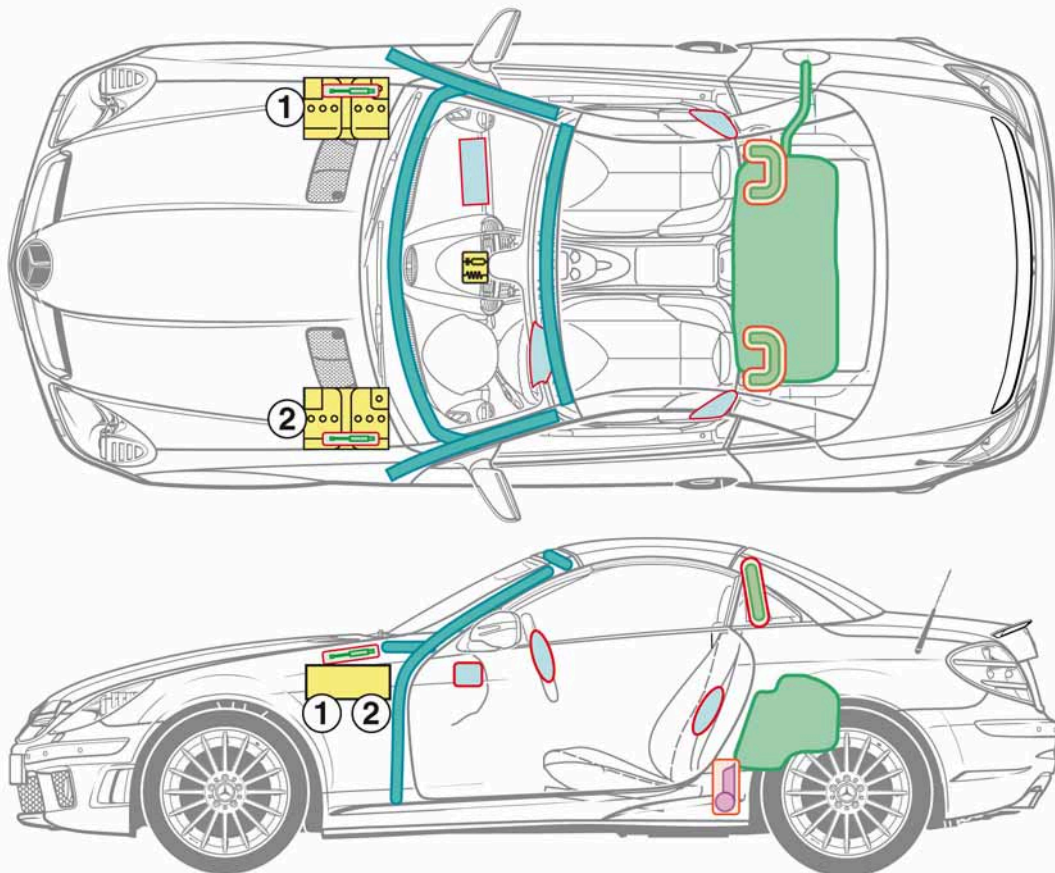

**Classe SLK
Roadster
Type 171**

2004-2011

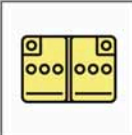
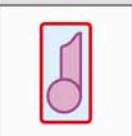
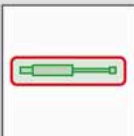

1 direction à gauche
2 direction à droite

Légende

	Airbag		Renfort de carrosserie		Calculateur
	Générateur de gaz		Arceau de sécurité		Batterie
	Rétracteur de ceinture		Amortisseur à gaz		Réservoir de carburant

**Classe SLK
Roadster
Type 172**



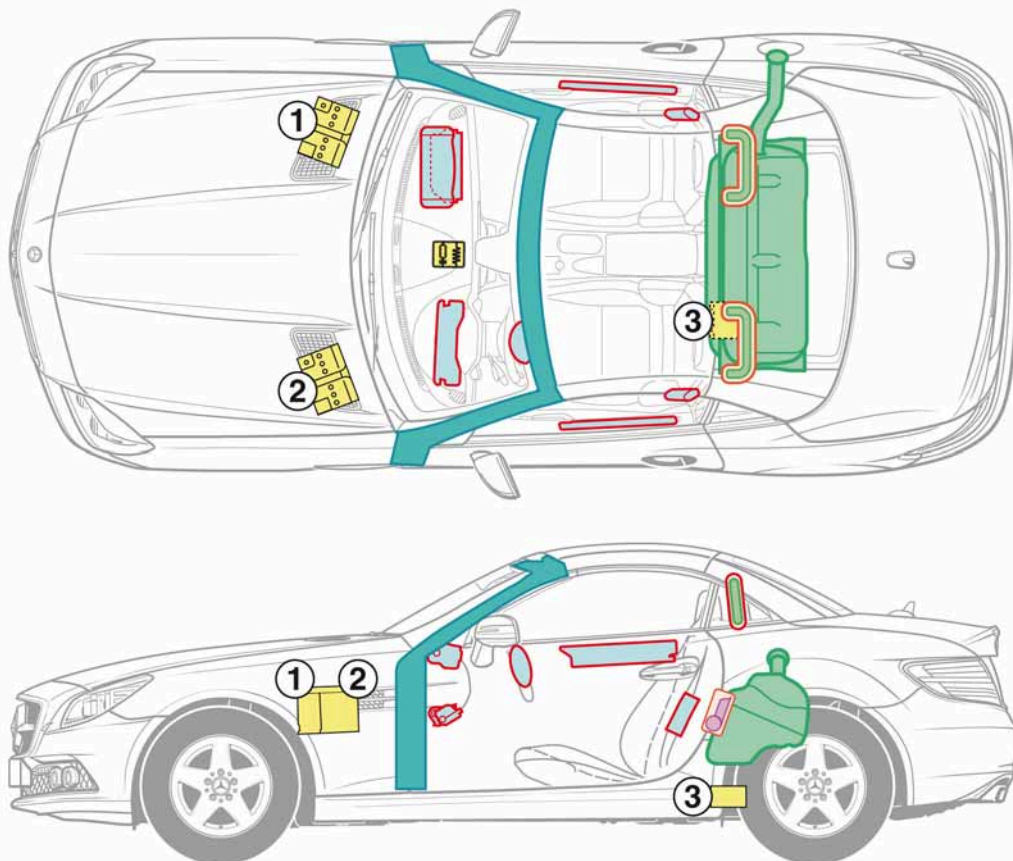





à partir de 2011



1 batterie du réseau de bord, direction à gauche
2 batterie du réseau de bord, direction à droite

3 batterie additionnelle ECO Start-Stop

Légende





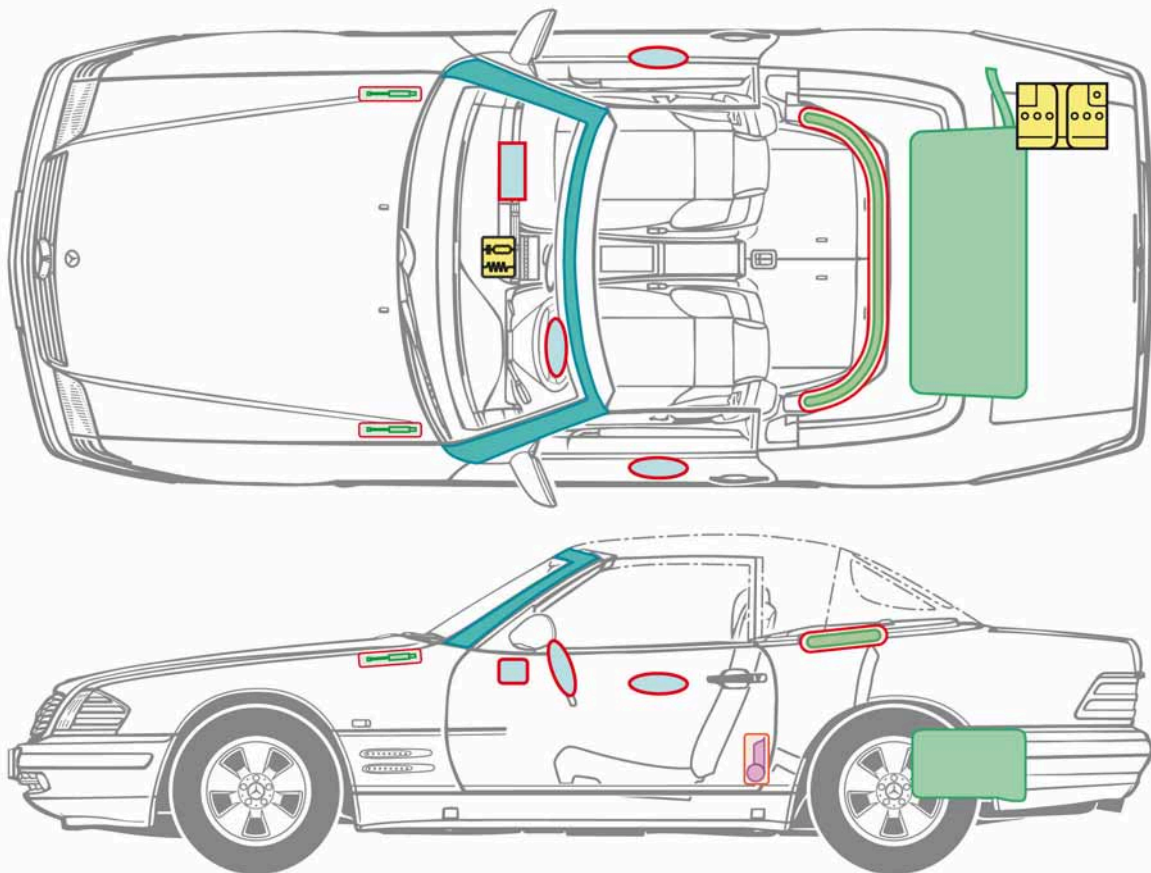

	Airbag		Renfort de carrosserie		Calculateur
	Générateur de gaz		Arceau de sécurité		Batterie
	Rétracteur de ceinture		Amortisseur à gaz		Réservoir de carburant

**Classe SL
Roadster
Type 129**

1989-2001

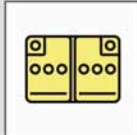
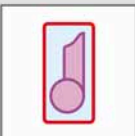
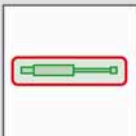

Légende

	Airbag		Renfort de carrosserie		Calculateur
	Générateur de gaz		Arceau de sécurité		Batterie
	Rétracteur de ceinture		Amortisseur à gaz		Réservoir de carburant

**Classe SL
Roadster
Type 230**



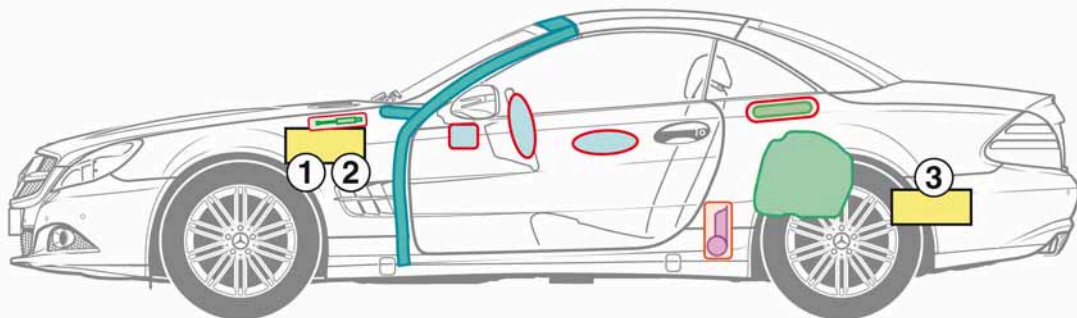
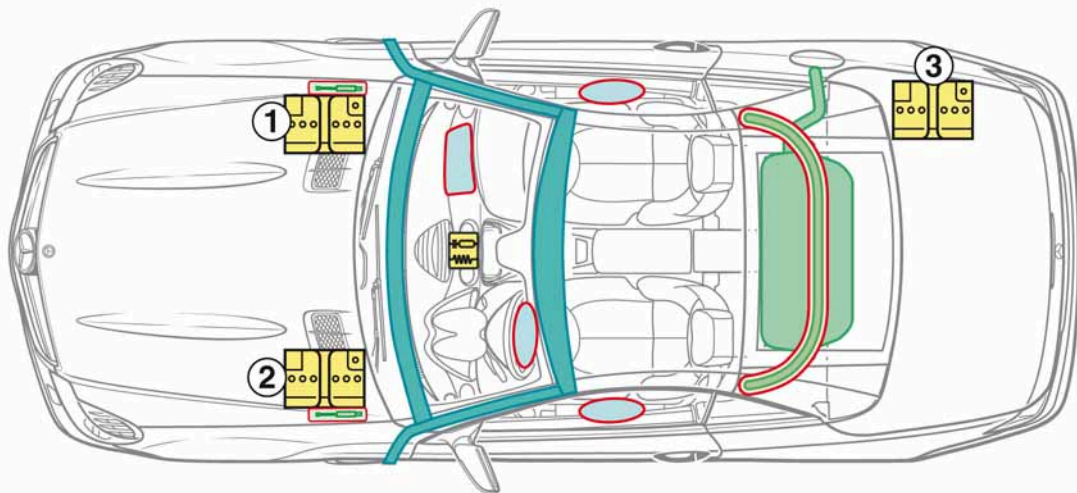





à partir de 2001

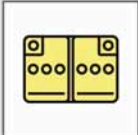

1 batterie de démarrage, direction à gauche
2 batterie de démarrage, direction à droite

3 batterie du réseau de bord

Légende

	Airbag		Renfort de carrosserie		Calculateur
	Générateur de gaz		Arceau de sécurité		Batterie
	Rétracteur de ceinture		Amortisseur à gaz		Réservoir de carburant





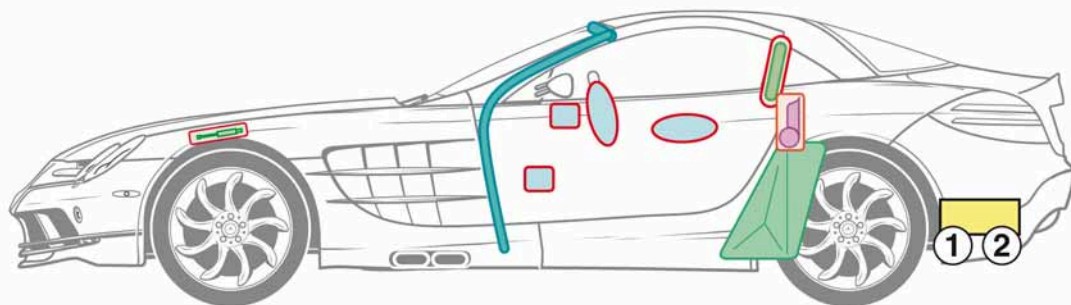
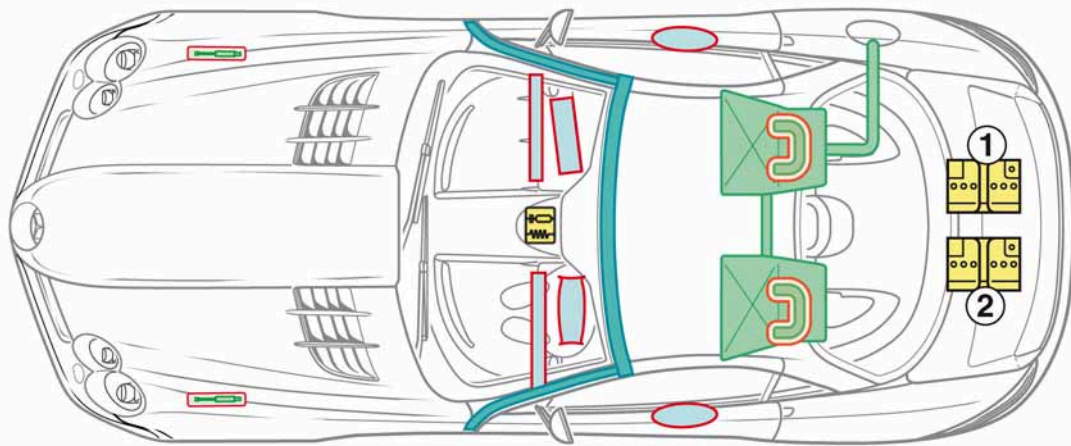



**SLR
McLaren
Type 199**

2004-2009

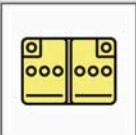

- 1 batterie de démarrage
- 2 batterie du réseau de bord

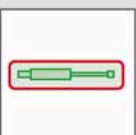
Légende

	Airbag		Renfort de carrosserie		Calculateur
	Générateur de gaz		Arceau de sécurité		Batterie
	Rétracteur de ceinture		Amortisseur à gaz		Réservoir de carburant

Classe G
Véhicule
tout-terrain
Type 463



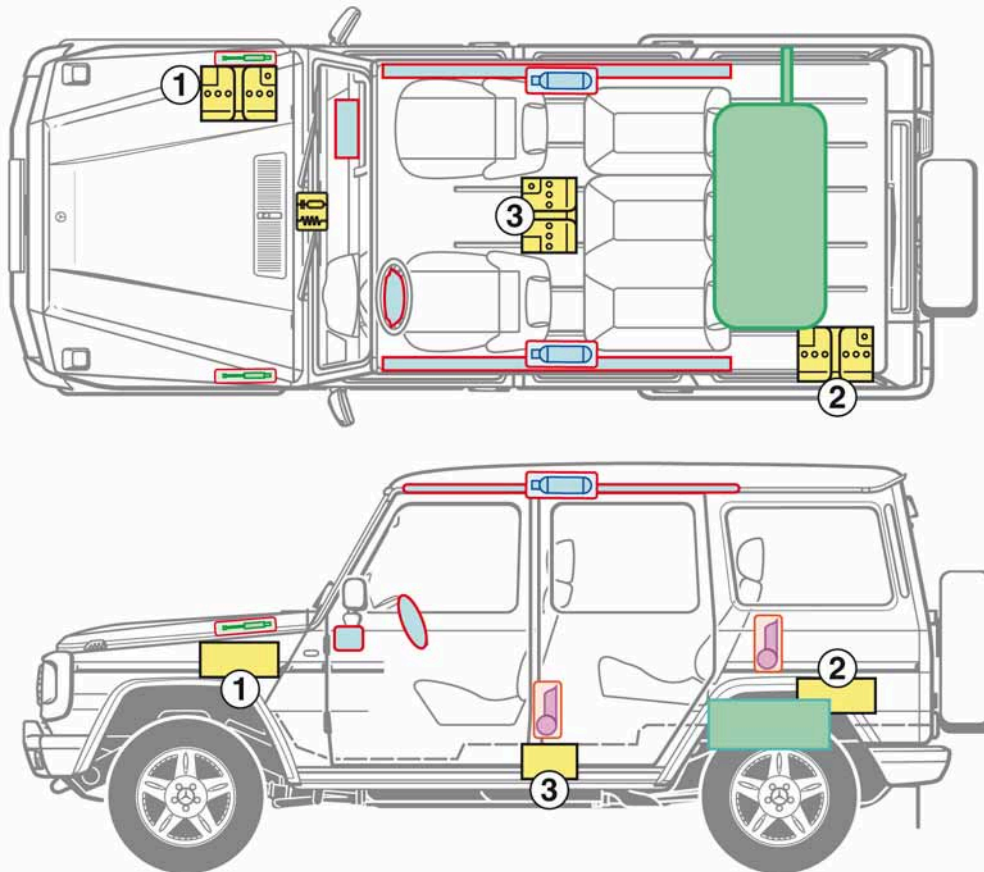





à partir de 1990

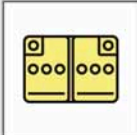

1 jusqu'à 09.1996
 2 à partir de 10.1996 jusqu'à 11.2000

3 à partir de 12.2000

Légende

	Airbag		Renfort de carrosserie		Calculateur
	Générateur de gaz		Arceau de sécurité		Batterie
	Rétracteur de ceinture		Amortisseur à gaz		Réservoir de carburant





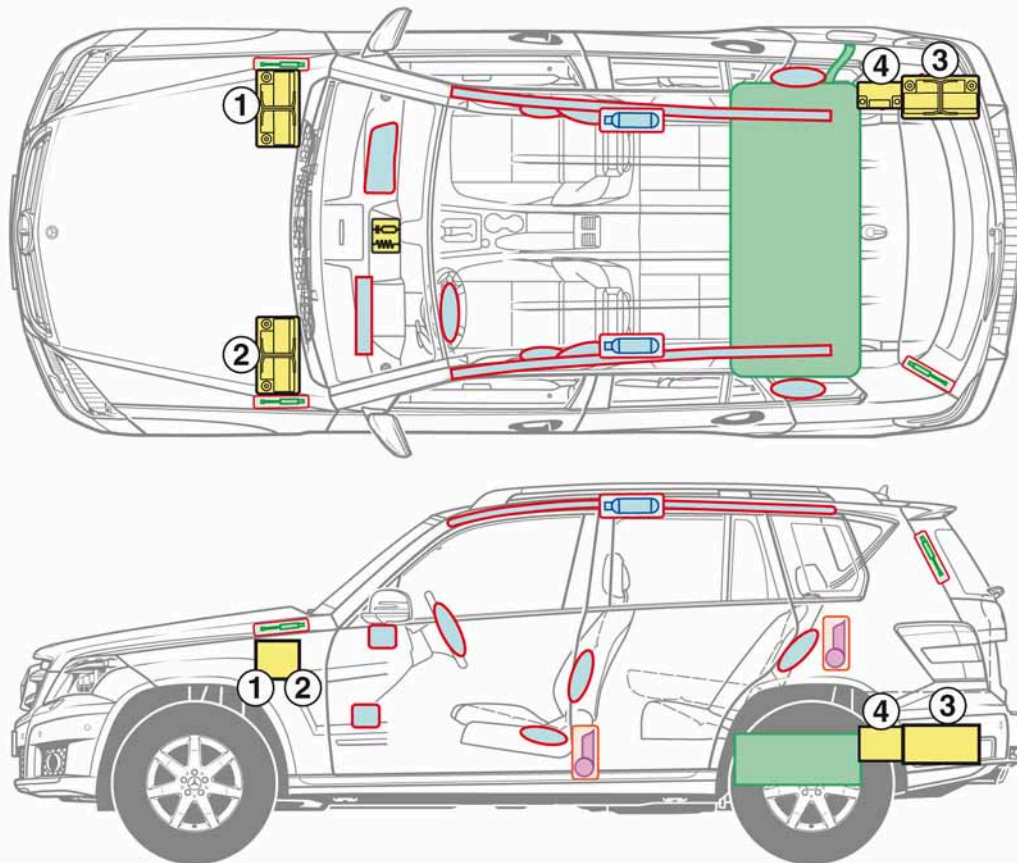



Classe GLK
Véhicule
tout-terrain
Type 204

à partir de 2008

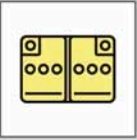

- 1 batterie en véhicules à moteur essence, à partir de 1.12.09 en véhicules à moteur diesel (4- et 8-cyl. , dir. à gauche
- 2 batterie en véhicules à moteur essence, à partir de 1.12.09 en véhicules à moteur diesel (4- et 8-cyl.), dir. à droite
- 3 batterie en véhicules à moteur diesel , jusqu'à 30.11.09 en véhicules à moteur diesel (4- et 8-cyl.)
- 4 batterie additionnelle ECO Start-Stop

Légende

	Airbag		Renfort de carrosserie		Calculateur
	Générateur de gaz		Arceau de sécurité		Batterie
	Rétracteur de ceinture		Amortisseur à gaz		Réservoir de carburant





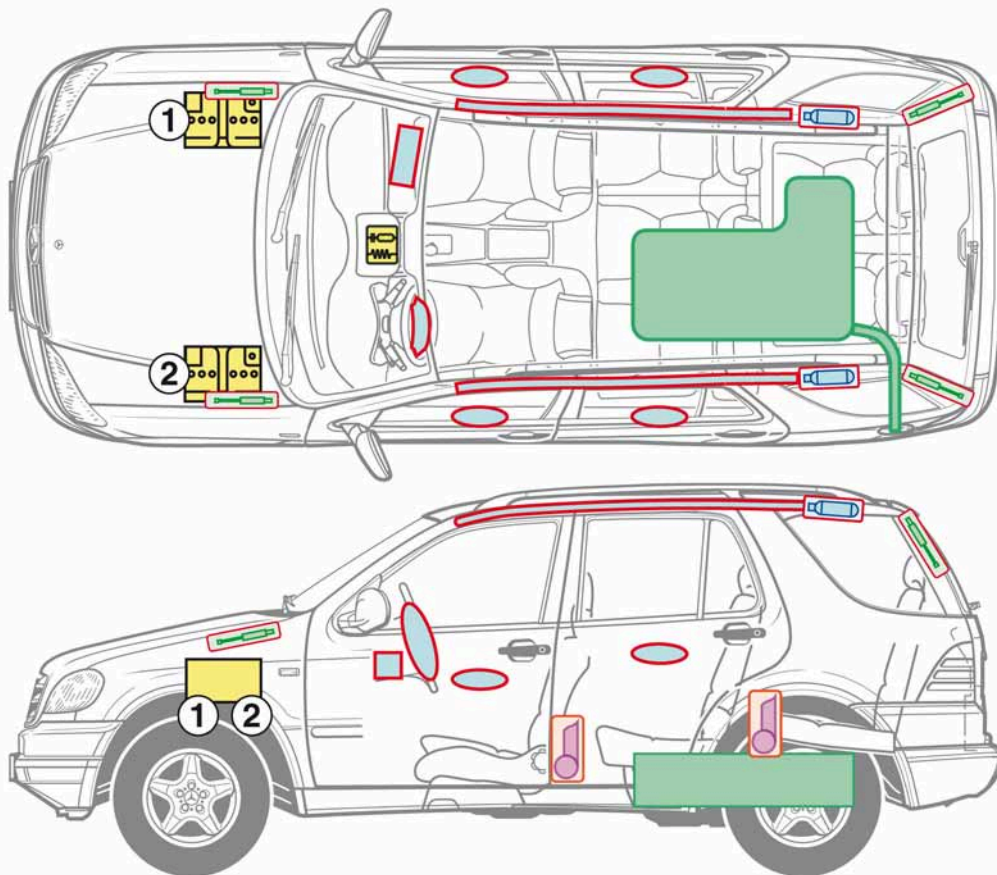

Classe M
Véhicule
tout-terrain
Type 163

1997-2005

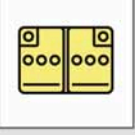
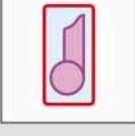
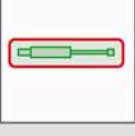

1 direction à gauche
 2 direction à droite

Légende

	Airbag		Renfort de carrosserie		Calculateur
	Générateur de gaz		Arceau de sécurité		Batterie
	Rétracteur de ceinture		Amortisseur à gaz		Réservoir de carburant





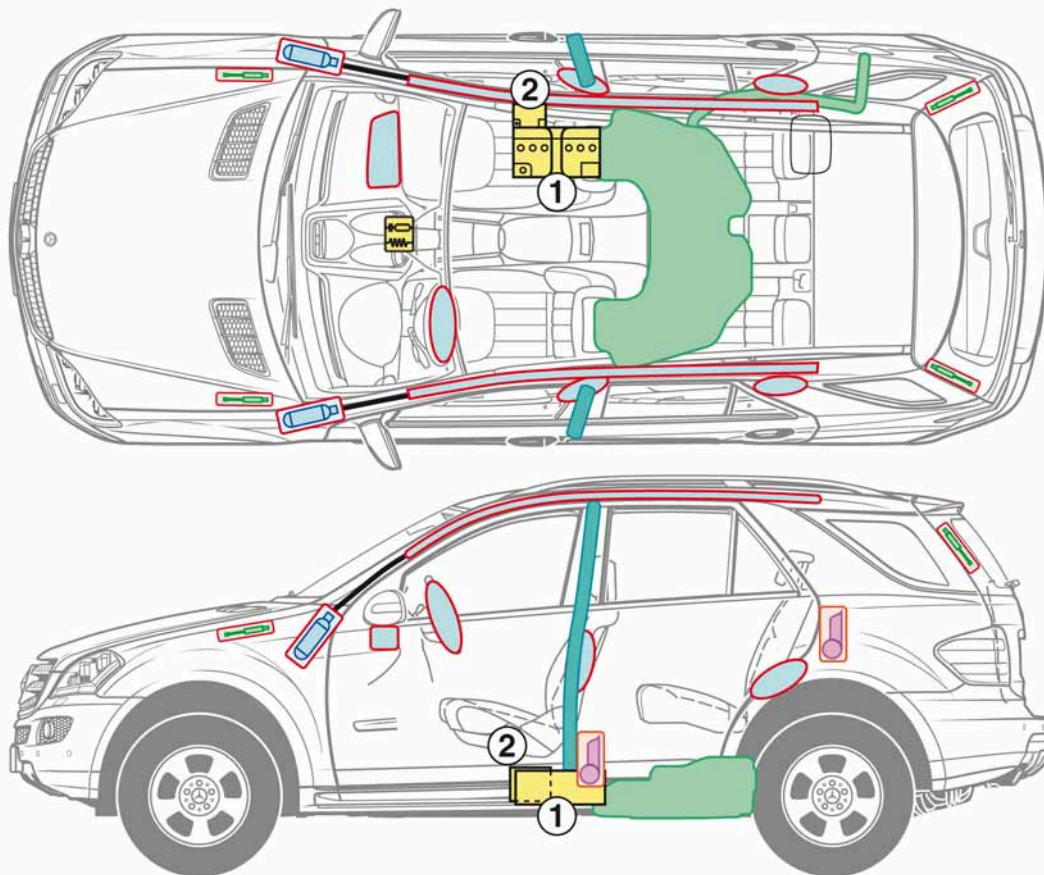

Classe M
Véhicule
tout-terrain
Type 164

à partir de 2005

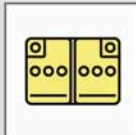
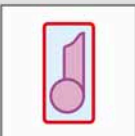
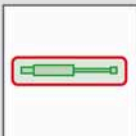

- 1 batterie principale
- 2 batterie supplémentaire

Légende

	Airbag		Renfort de carrosserie		Calculateur
	Générateur de gaz		Arceau de sécurité		Batterie
	Rétracteur de ceinture		Amortisseur à gaz		Réservoir de carburant



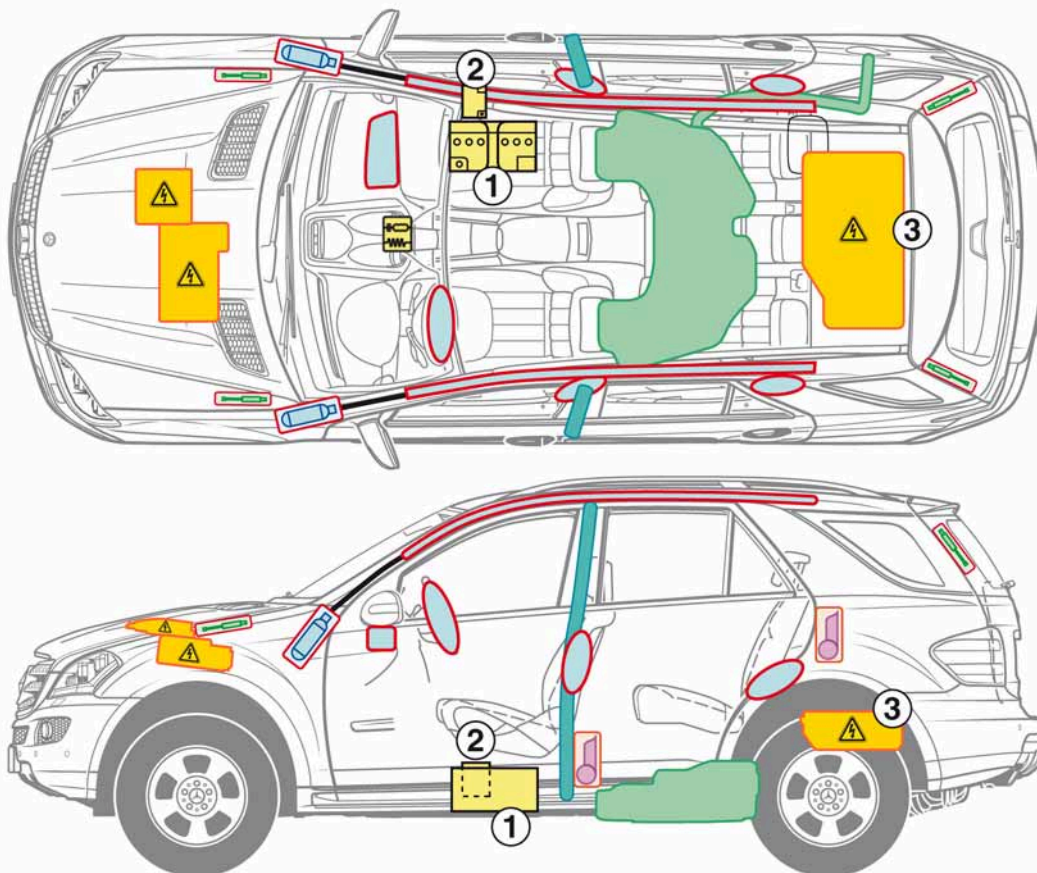





**Classe M
HYBRID**
Véhicule
tout-terrain
Type 164
à partir de 2009

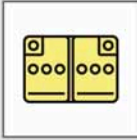

1 batterie principale
2 batterie supplémentaire

3 batterie haute tension

Légende

	Airbag		Renfort de carrosserie		Calculateur
	Générateur de gaz		Composants haute tension		Batterie
	Rétracteur de ceinture		Amortisseur à gaz		Réservoir de carburant





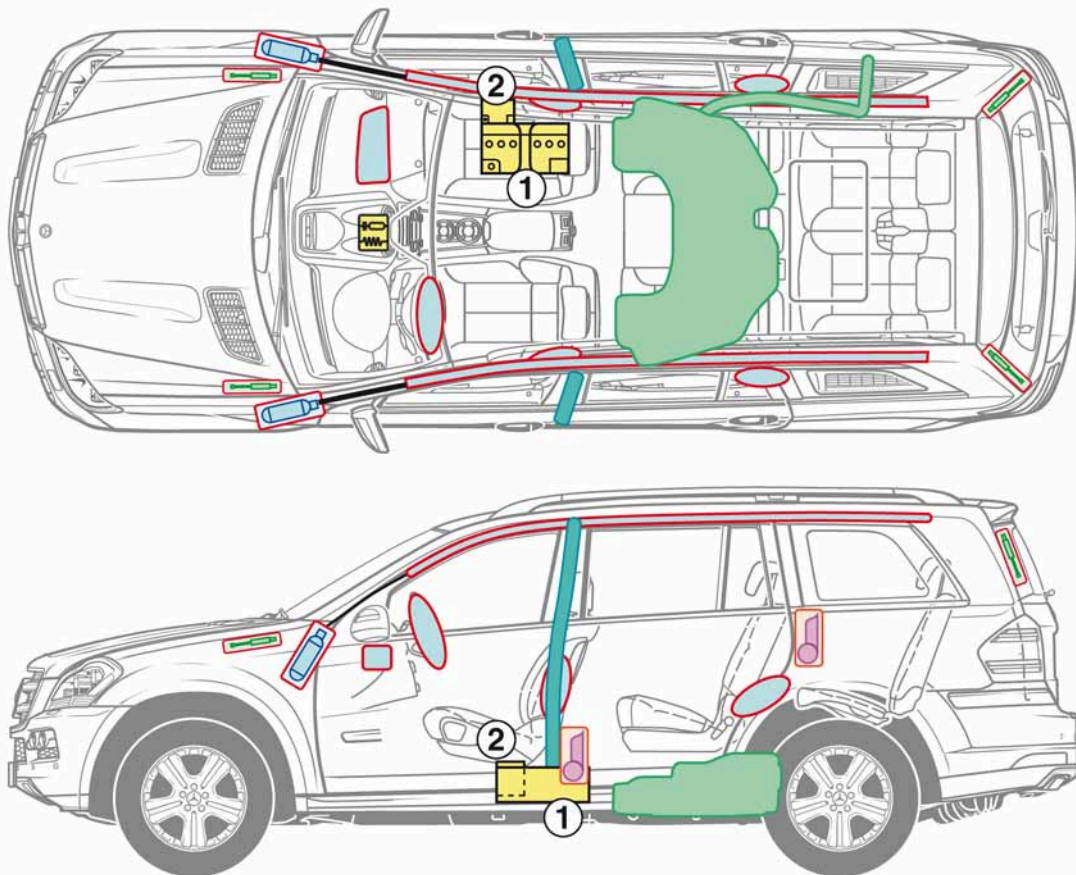



Classe GL
Véhicule
tout-terrain
Type 164

à partir de 2006

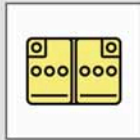

- 1 batterie principale
- 2 batterie supplémentaire

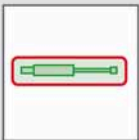
Légende

	Airbag		Renfort de carrosserie		Calculateur
	Générateur de gaz		Arceau de sécurité		Batterie
	Rétracteur de ceinture		Amortisseur à gaz		Réservoir de carburant





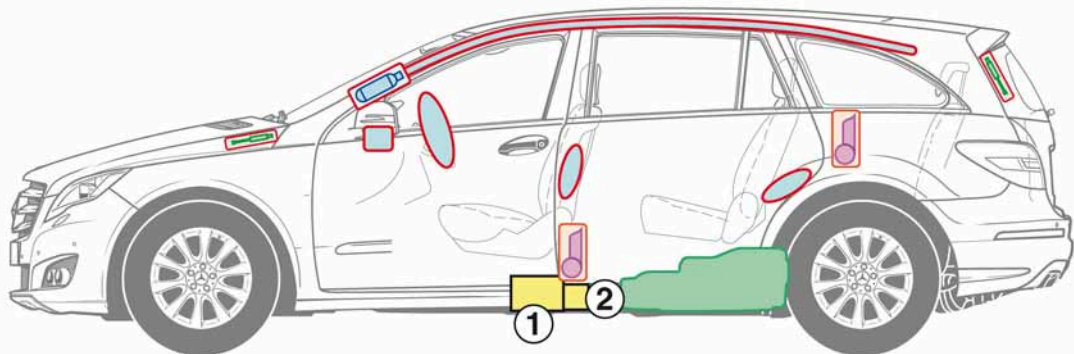
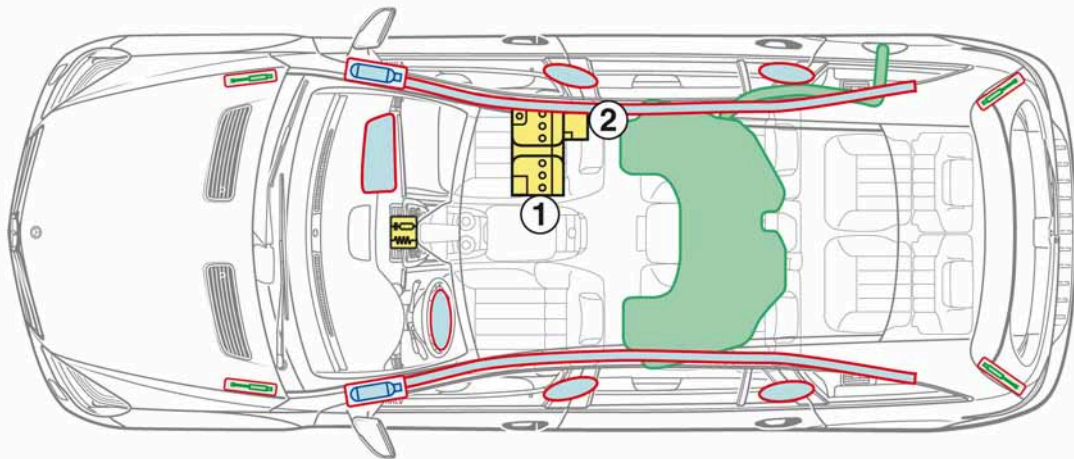

**Classe R
Van
Type 251**

à partir de 2005

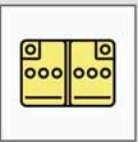
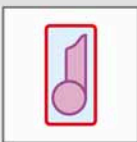
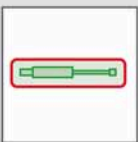

- 1 batterie principale
- 2 batterie supplémentaire

Légende







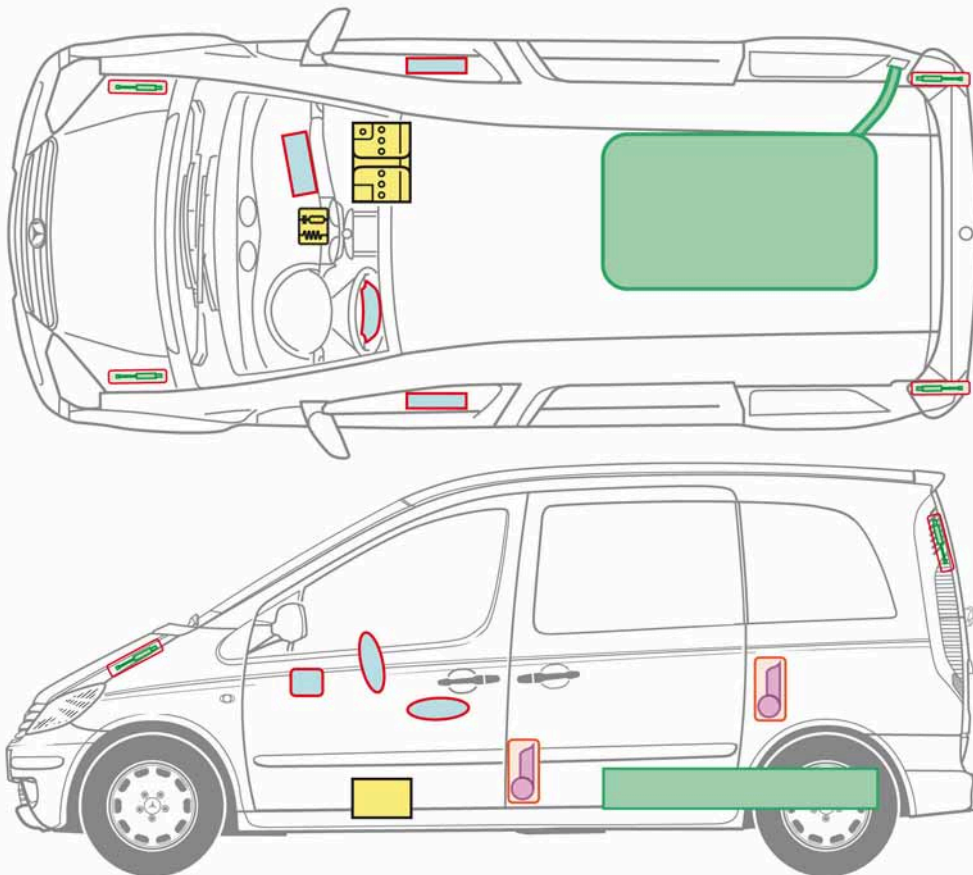

	Airbag		Renfort de carrosserie		Calculateur
	Générateur de gaz		Arceau de sécurité		Batterie
	Rétracteur de ceinture		Amortisseur à gaz		Réservoir de carburant

Vaneo
Type 414

2002-2005

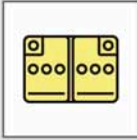

Légende







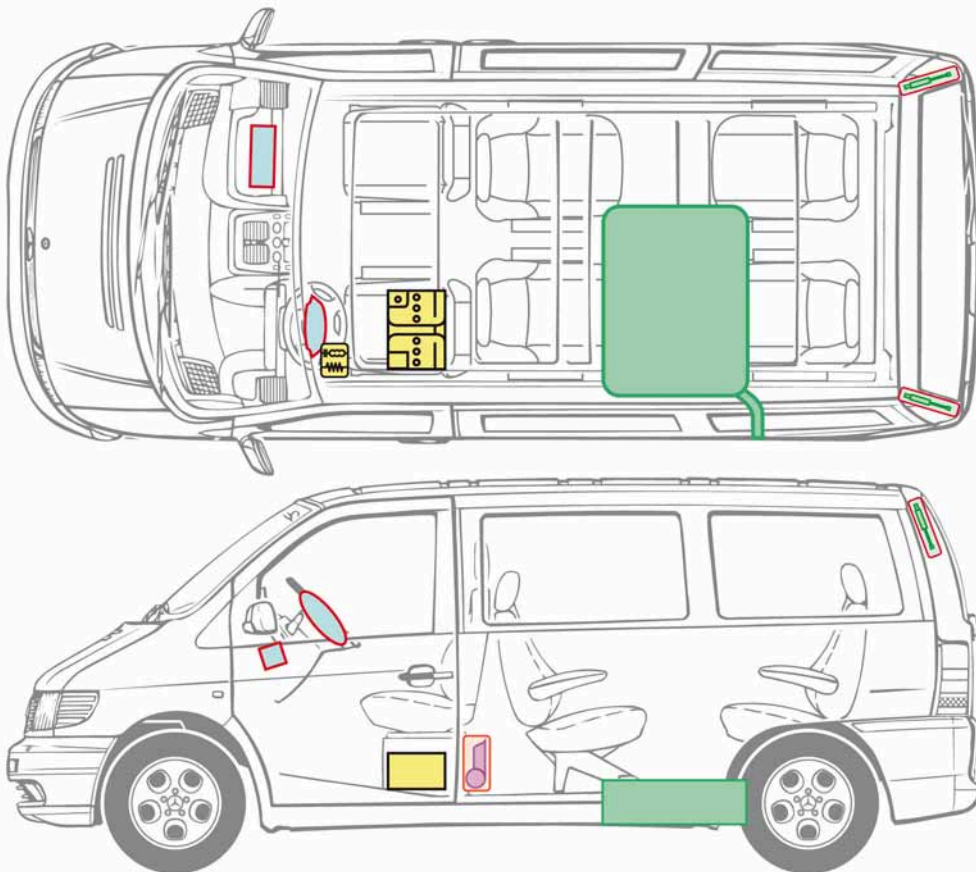

	Airbag		Renfort de carrosserie		Calculateur
	Générateur de gaz		Arceau de sécurité		Batterie
	Rétracteur de ceinture		Amortisseur à gaz		Réservoir de carburant

**Classe V
Vito
Type 638**

1996-2003

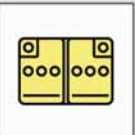

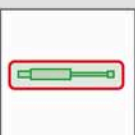
Légende





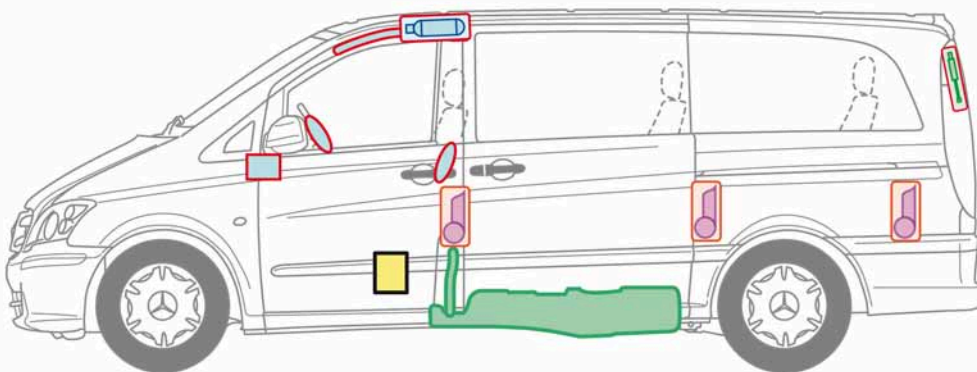
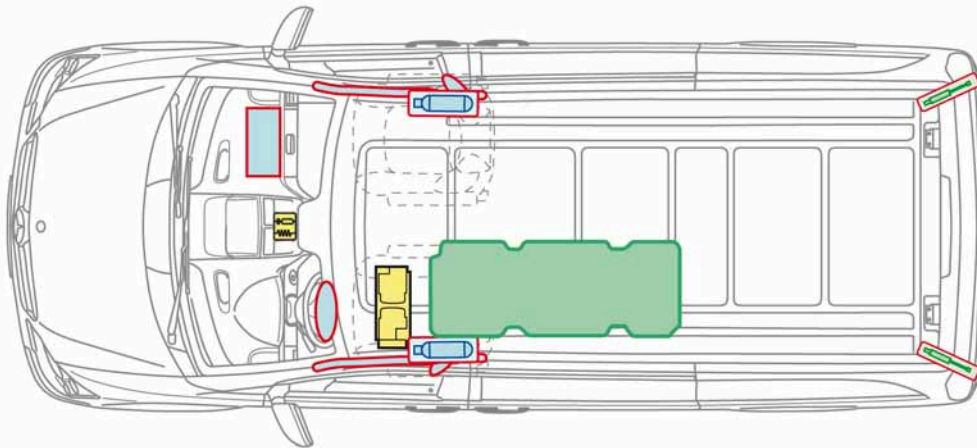

	Airbag		Renfort de carrosserie		Calculateur
	Générateur de gaz		Arceau de sécurité		Batterie
	Rétracteur de ceinture		Amortisseur à gaz		Réservoir de carburant

**Viano/Vito
Van
Type 639**

à partir de 2003

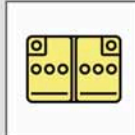
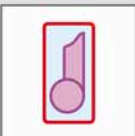

Légende







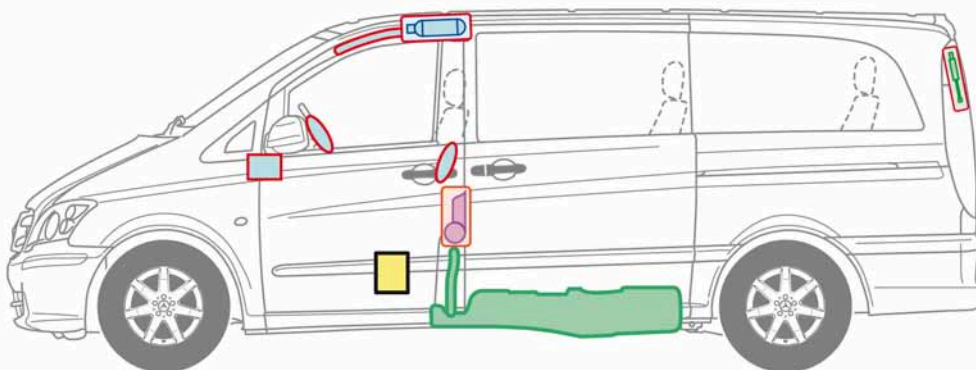
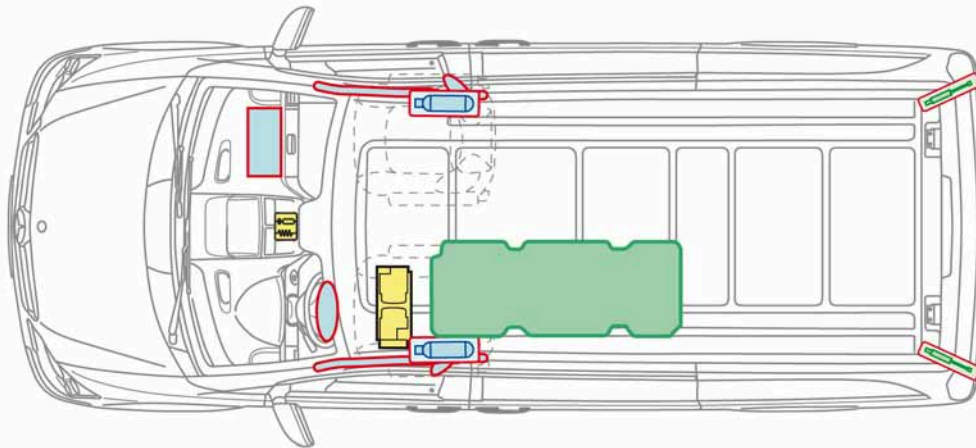

	Airbag		Renfort de carrosserie		Calculateur
	Générateur de gaz		Arceau de sécurité		Batterie
	Rétracteur de ceinture		Amortisseur à gaz		Réservoir de carburant

Viano
FUN
Type 639

à partir de 2003

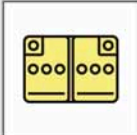

Légende

	Airbag		Renfort de carrosserie		Calculateur
	Générateur de gaz		Arceau de sécurité		Batterie
	Rétracteur de ceinture		Amortisseur à gaz		Réservoir de carburant

Viano
MARCO POLO
Westfalia
Type 639



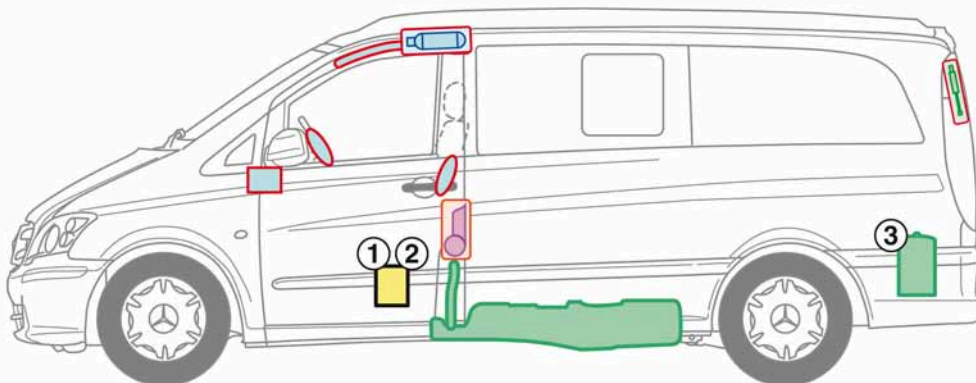
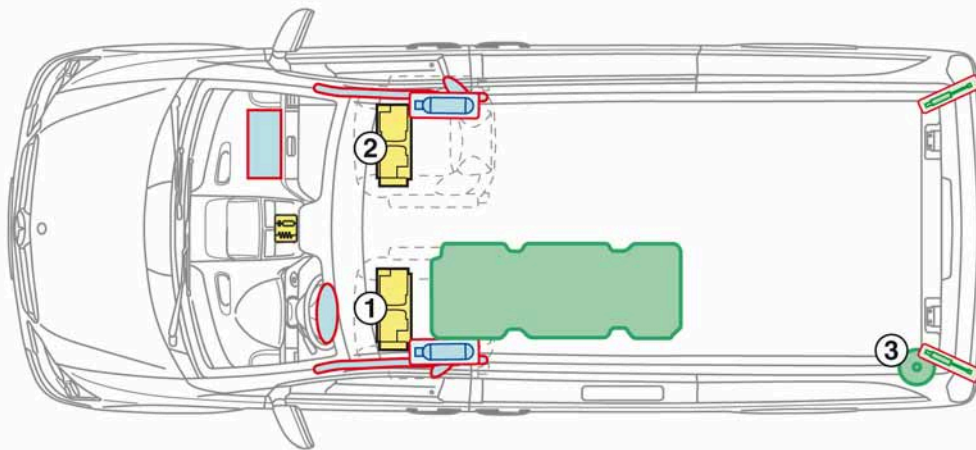





à partir de 2003

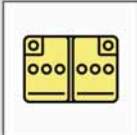

1 batterie principale
 2 batterie supplémentaire

3 réservoir à gaz (Camping Gaz, 2,8 kg)

Légende

	Airbag		Renfort de carrosserie		Calculateur
	Générateur de gaz		Arceau de sécurité		Batterie
	Rétracteur de ceinture		Amortisseur à gaz		Réservoir de carburant



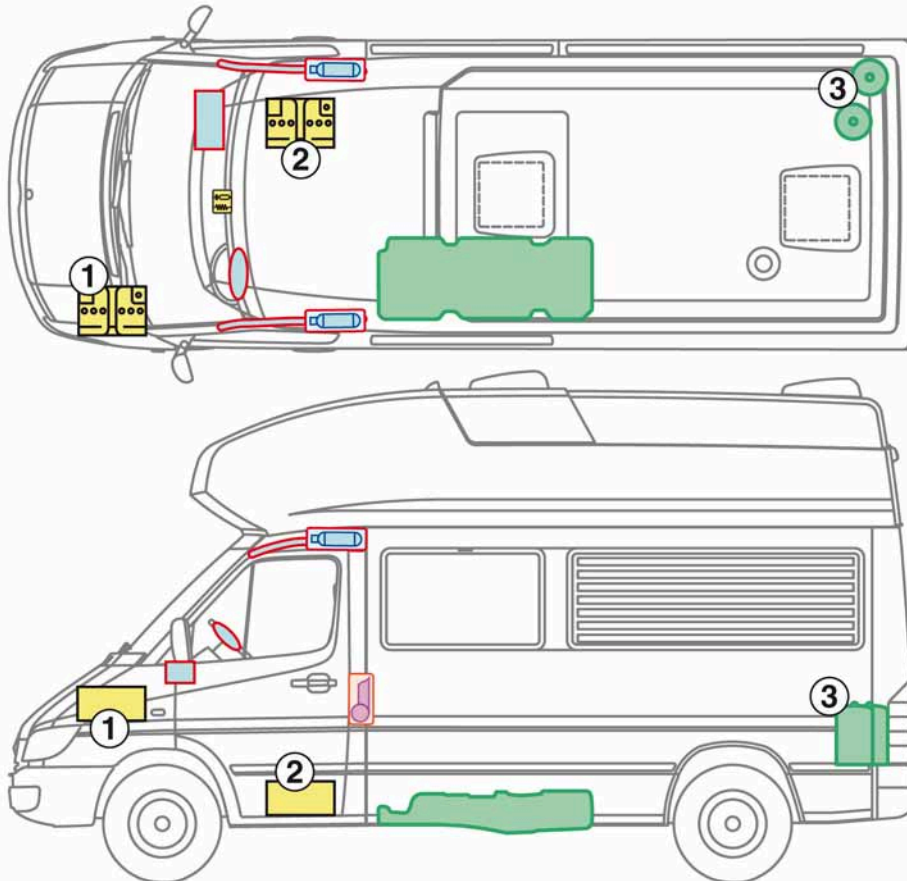





Sprinter
JAMES COOK
Westfalia
Type
901-905
1995-2006

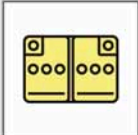

1 batterie de démarrage
 2 batterie supplémentaire

3 réservoir à gaz (Camping Gaz, 2x5 kg)

Légende

	Airbag		Renfort de carrosserie		Calculateur
	Générateur de gaz		Arceau de sécurité		Batterie
	Rétracteur de ceinture		Amortisseur à gaz		Réservoir de carburant

Sprinter
JAMES COOK
Westfalia
Type 906



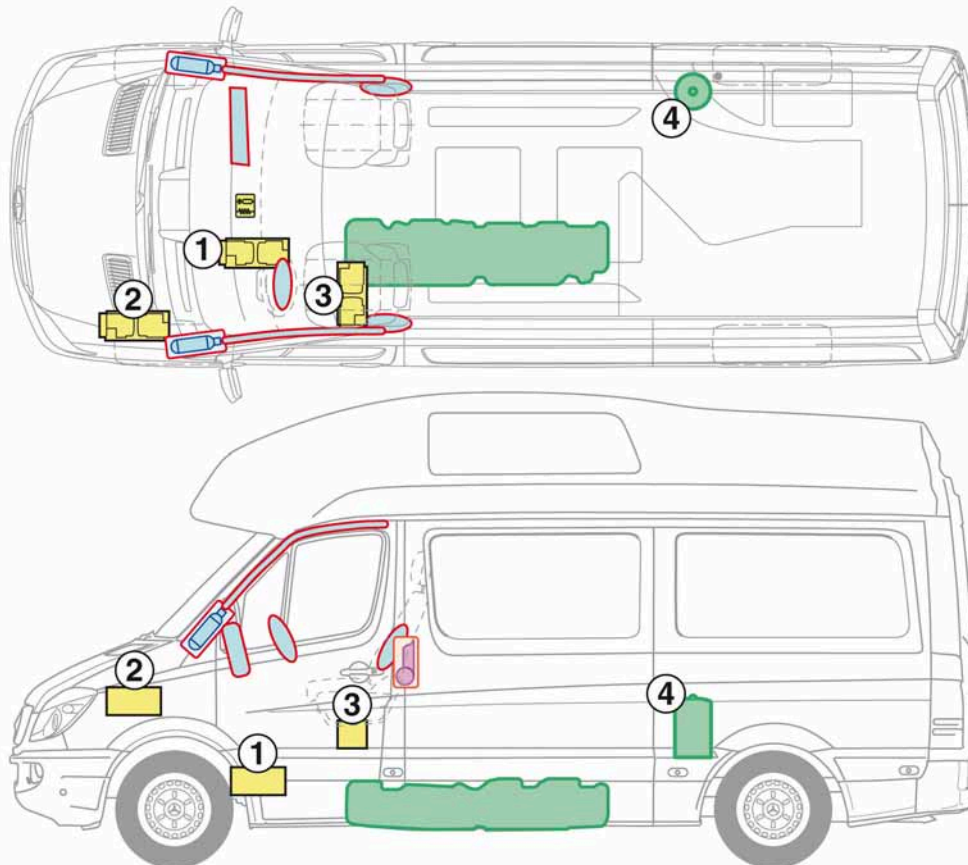



à partir de 2006



1 batterie de démarrage
 2 batterie supplémentaire, direction à gauche

3 batterie supplémentaire, direction à droite
 3 réservoir à gaz (Camping Gaz, 2,75 kg)

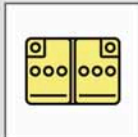
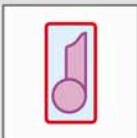
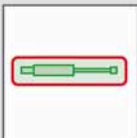
Légende







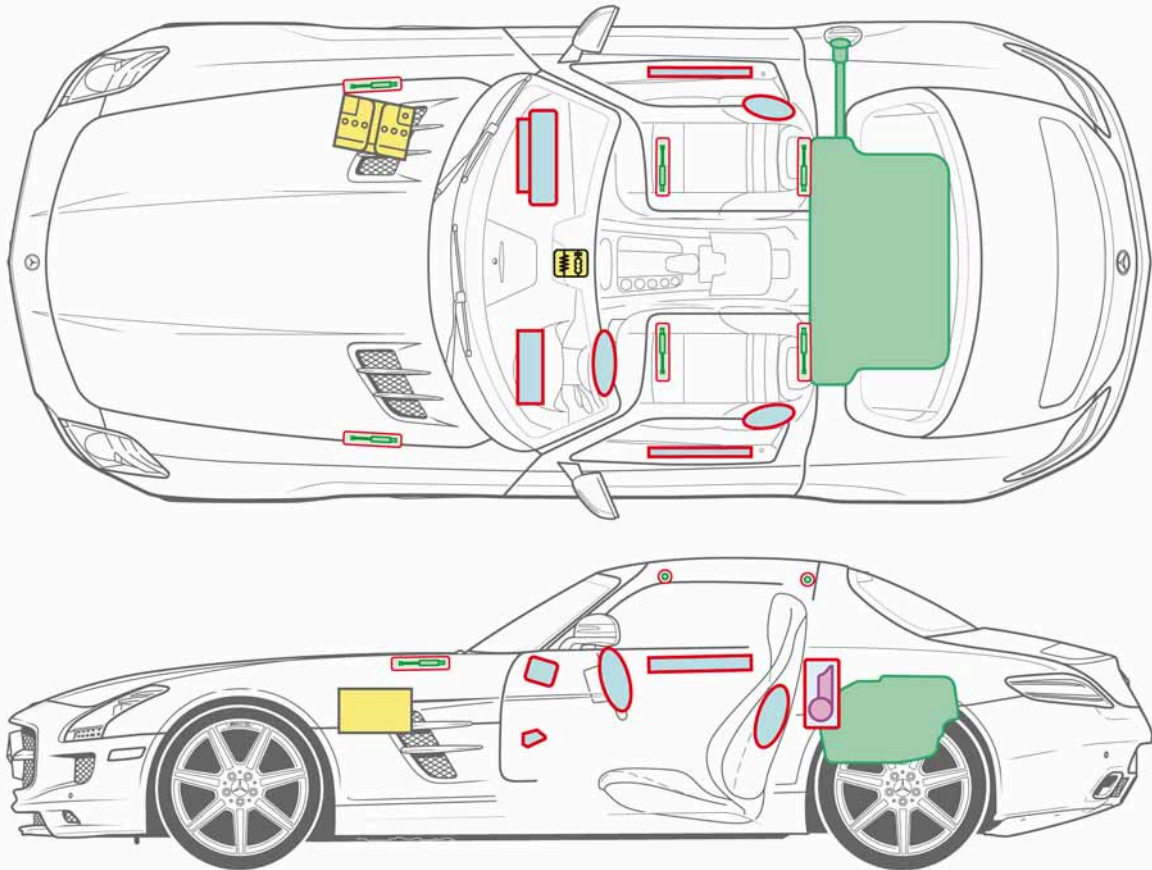

	Airbag		Renfort de carrosserie		Calculateur
	Générateur de gaz		Arceau de sécurité		Batterie
	Rétracteur de ceinture		Amortisseur à gaz		Réservoir de carburant

SLS
AMG
Type 197

à partir de 2010

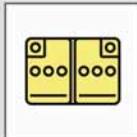

Légende

	Airbag		Renfort de carrosserie		Calculateur
	Générateur de gaz		Arceau de sécurité		Batterie
	Rétracteur de ceinture		Amortisseur à gaz		Réservoir de carburant







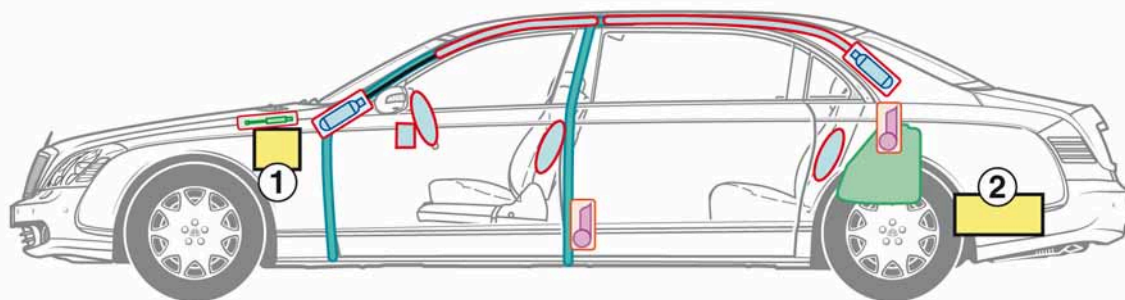
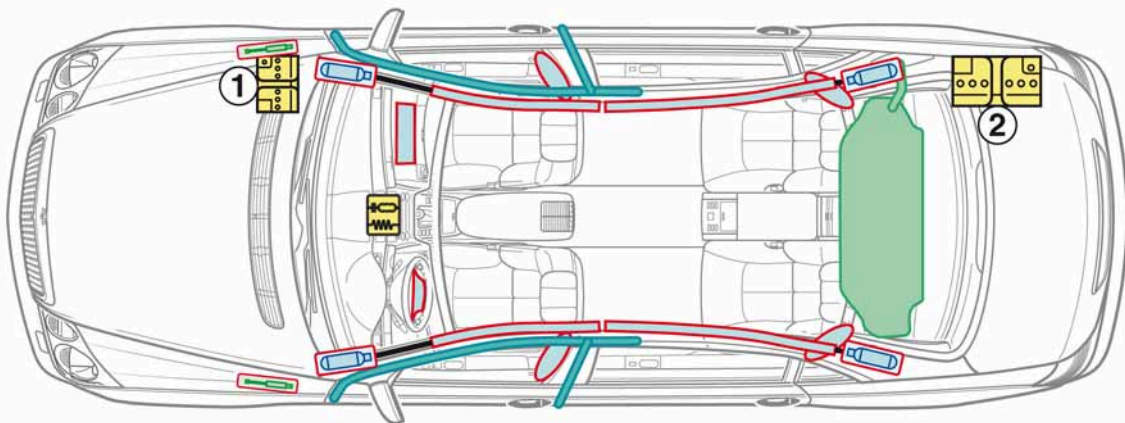

**Maybach
Berline
Type 240**

à partir de 2002

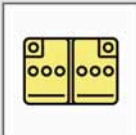
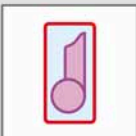
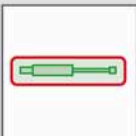

- 1 batterie de démarrage compartiment moteur
- 2 batterie du réseau de bord coffre à bagages

Légende

	Airbag		Renfort de carrosserie		Calculateur
	Générateur de gaz		Arceau de sécurité		Batterie
	Rétracteur de ceinture		Amortisseur à gaz		Réservoir de carburant

smart
fortwo
coupé
Type 450

1998-2007

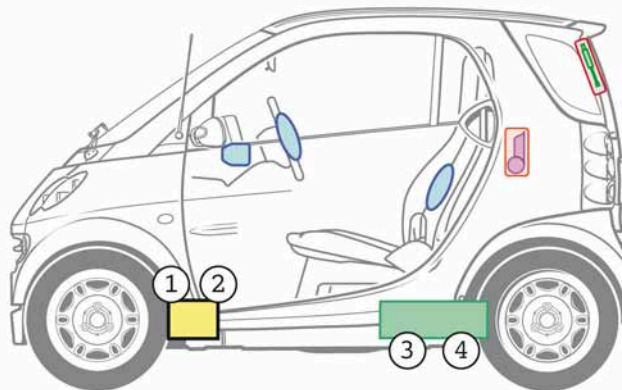
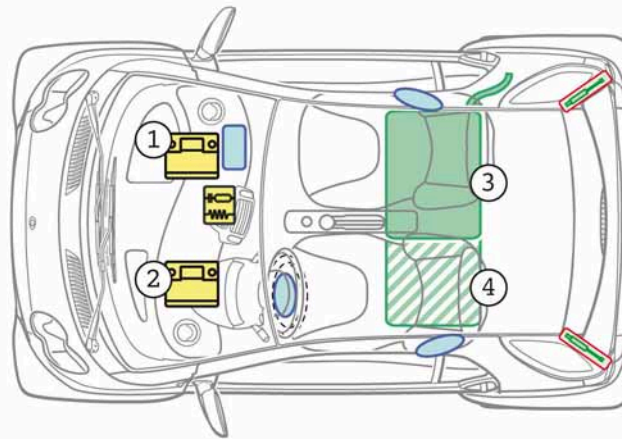

1 direction à gauche
2 direction à droite

3 réservoir de carburant moteur diesel
4 réservoir de carburant moteur essence

Légende

	Airbag		Renfort de carrosserie		Calculateur
	Générateur de gaz		Arceau de sécurité		Batterie
	Rétracteur de ceinture		Amortisseur à gaz		Réservoir de carburant

smart
fortwo
Cabrio
Type 450

1998-2007

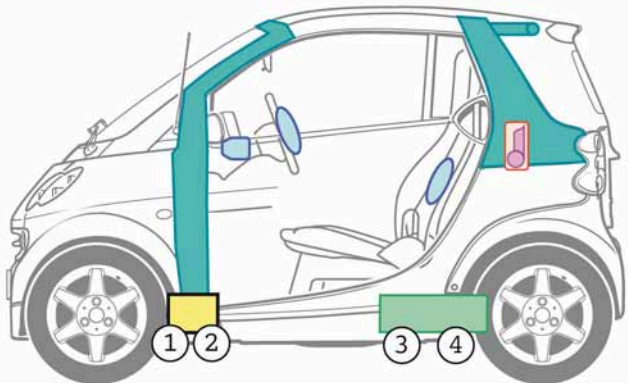
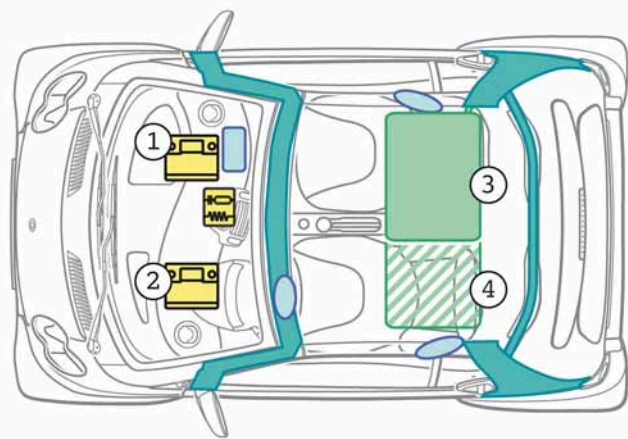

1 direction à gauche
2 direction à droite

3 réservoir de carburant moteur diesel
4 réservoir de carburant moteur essence

Légende

	Airbag		Renfort de carrosserie		Calculateur
	Générateur de gaz		Arceau de sécurité		Batterie
	Rétracteur de ceinture		Amortisseur à gaz		Réservoir de carburant

smart
fortwo
coupé
Type 451

à partir de 2007

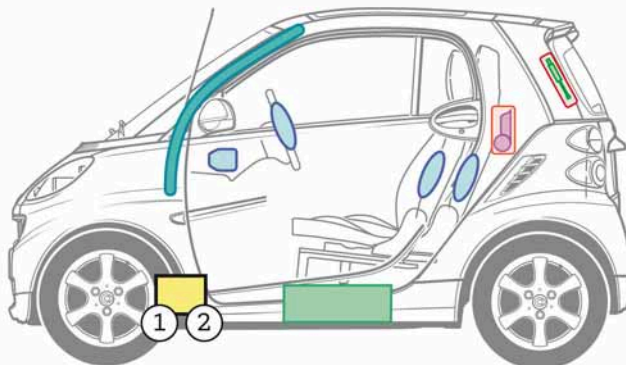
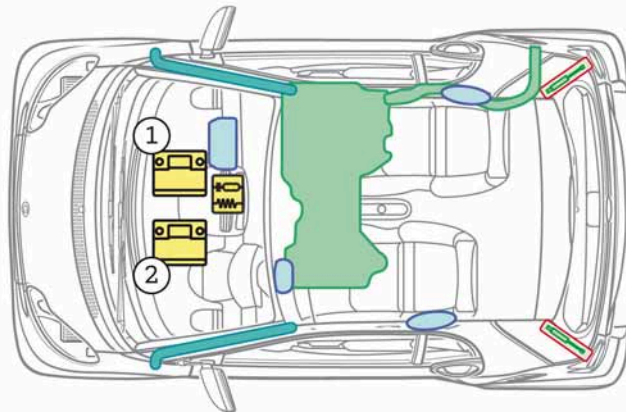

- 1 direction à gauche
2 direction à droite

Légende

	Airbag		Renfort de carrosserie		Calculateur
	Générateur de gaz		Arceau de sécurité		Batterie
	Rétracteur de ceinture		Amortisseur à gaz		Réservoir de carburant

smart
fortwo
Cabrio
Type 451

à partir de 2007

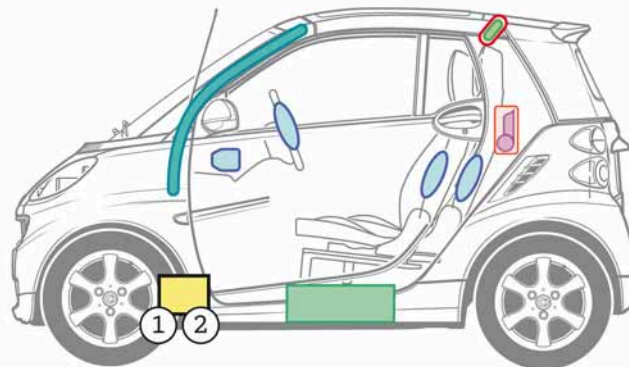
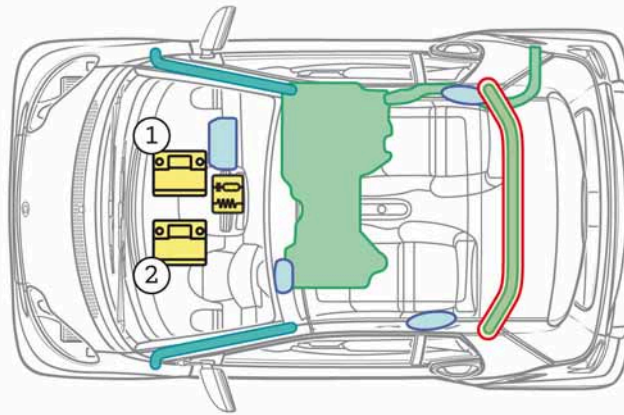

- 1 direction à gauche
2 direction à droite

Légende

	Airbag		Renfort de carrosserie		Calculateur
	Générateur de gaz		Arceau de sécurité		Batterie
	Rétracteur de ceinture		Amortisseur à gaz		Réservoir de carburant

smart
fortwo
coupé
electric drive
Type 451
à partir de 2009

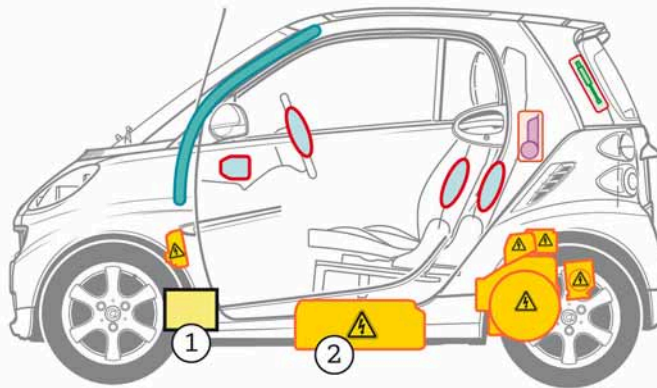
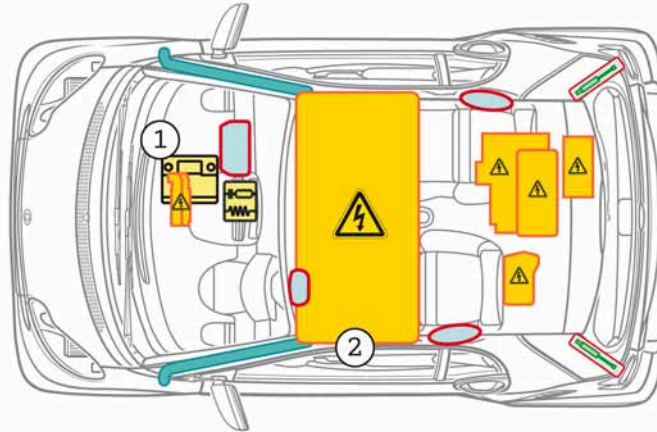

- 1 batterie 12 V
- 2 batterie haute tension

Légende

	Airbag		Renfort de carrosserie		Calculateur
	Générateur de gaz		Arceau de sécurité		Batterie
	Rétracteur de ceinture		Amortisseur à gaz		Composants haute tension

smart
fortwo
Cabrio
electric drive
Type 451
à partir de 2009

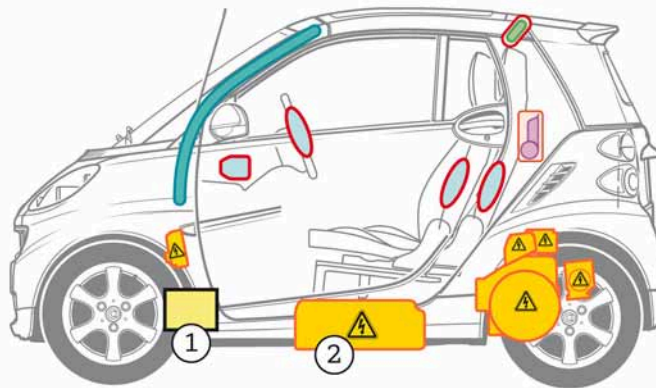
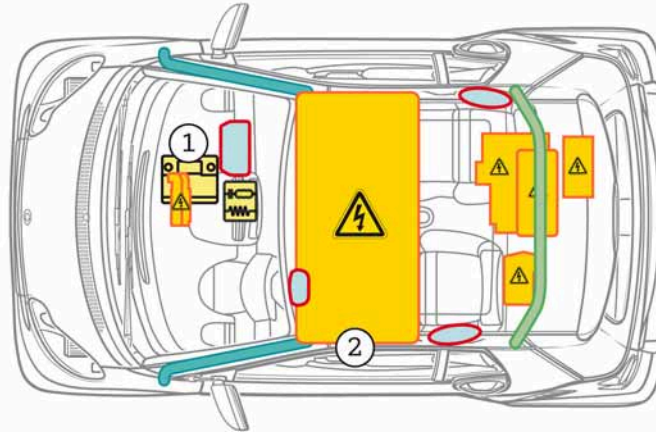

- 1 batterie 12 V
- 2 batterie haute tension

Légende

	Airbag		Renfort de carrosserie		Calculateur
	Générateur de gaz		Arceau de sécurité		Batterie
	Rétracteur de ceinture		Amortisseur à gaz		Composants haute tension

smart
roadster
Type 452

2003-2005

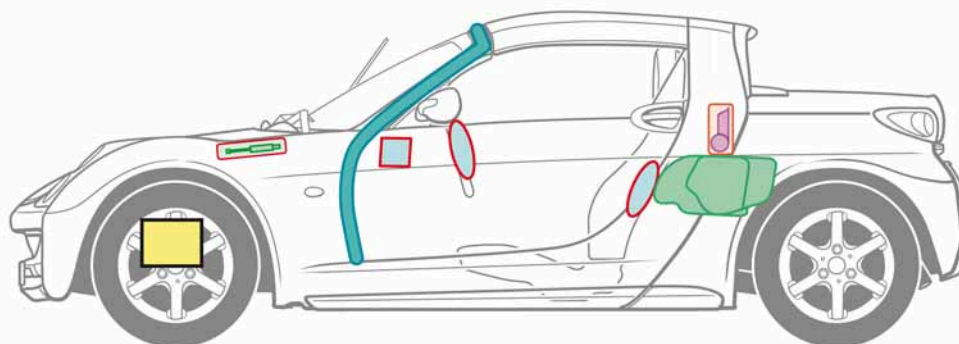
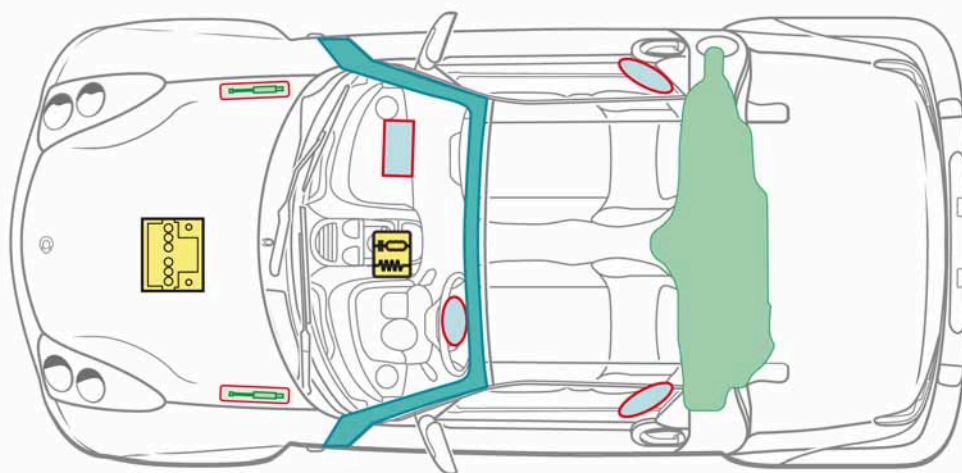

Légende

	Airbag		Renfort de carrosserie		Calculateur
	Générateur de gaz		Arceau de sécurité		Batterie
	Rétracteur de ceinture		Amortisseur à gaz		Réservoir de carburant

smart
roadster
coupé
Type 452

2003-2005

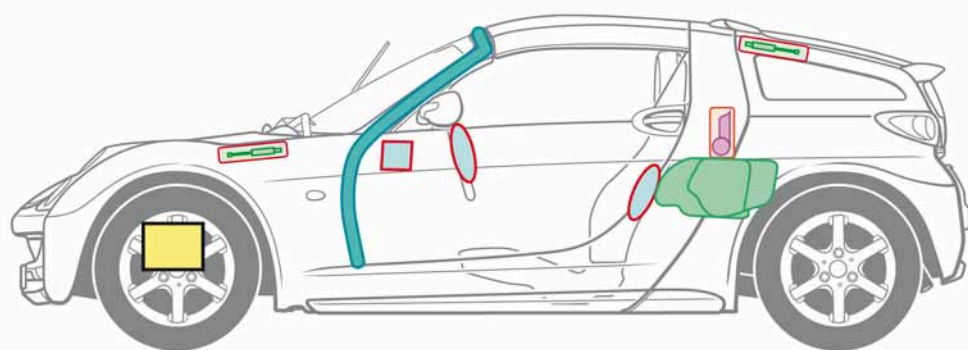
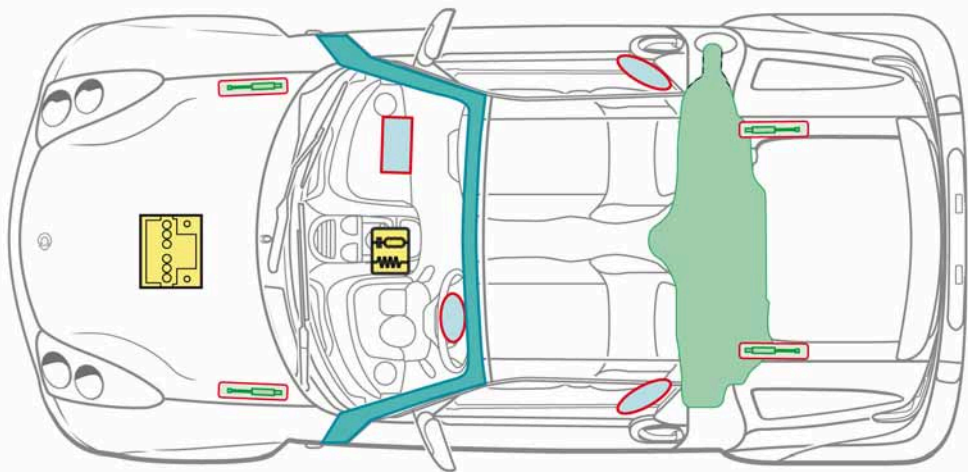

Légende

	Airbag		Renfort de carrosserie		Calculateur
	Générateur de gaz		Arceau de sécurité		Batterie
	Rétracteur de ceinture		Amortisseur à gaz		Réservoir de carburant

smart
forfour
Type 454

2004-2006

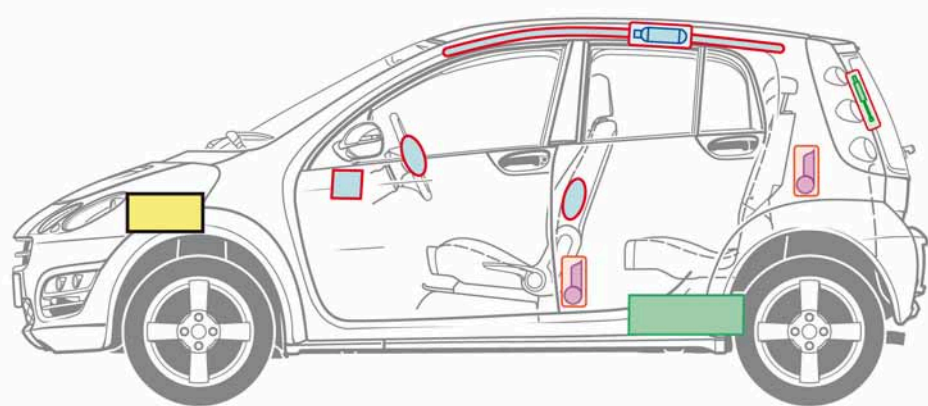
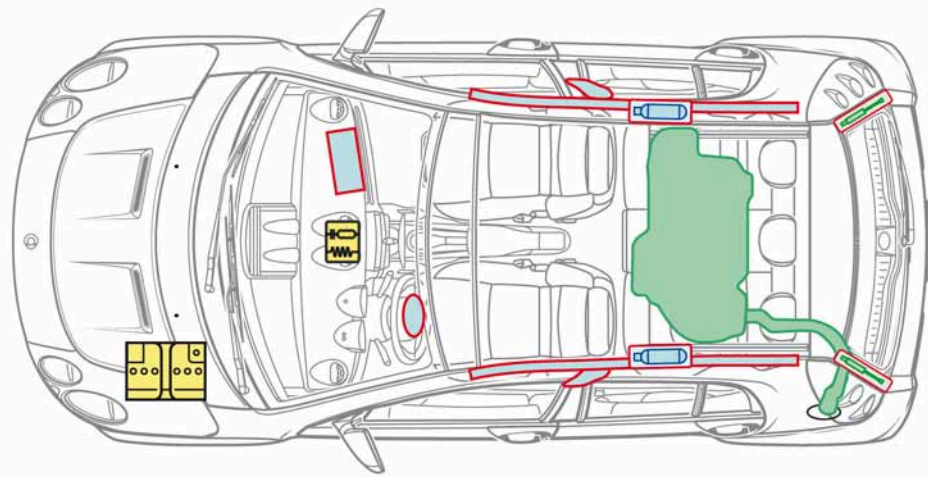

Légende

	Airbag		Renfort de carrosserie		Calculateur
	Générateur de gaz		Arceau de sécurité		Batterie
	Rétracteur de ceinture		Amortisseur à gaz		Réservoir de carburant

